

Retro



 colour included
in the price



Retro 800↑ × 504↔ SX
colour: Chrome

Star angled regulating valve set, chrome
Pipe-masking set, chrome



TERMA
SINCE 1990





colour included in the price

Design : *Terma*

Standard connection:



Electric radiators:



Available sizes:

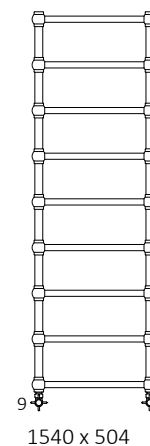
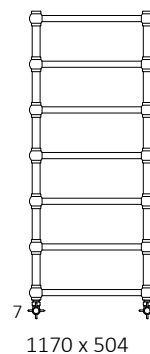
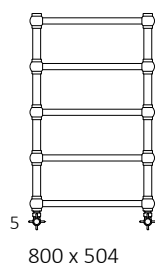
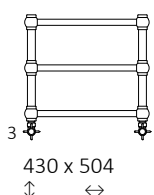

Specification:

Working pressure: 1000 kPa Maximum operating temperature: 95°C

A ↓ [mm]	B ↔ [mm]	C2 [mm]	75/65/20°C [W]	55/45/20°C [W]	☺ [W]	D [mm]	E [mm]	F [mm]	H [dm ²]	⚖️ [kg]	Product code <small>Configuration code p. 5</small>
Powder coating											
430	504	450	115	63	120	450	370	30	1,05	5,57	WGRE1043050
800	504	450	210	114	200	450	740	30	1,88	8,49	WGRE1080050
1170	504	450	308	165	300	450	1110	30	2,71	11,40	WGRE1117050
1540	504	450	405	216	400	450	1480	30	3,54	14,32	WGRE1154050
Plated finishes											
430	504	450	81	44	120	450	370	30	1,05	5,48	WGRE1043050
800	504	450	147	80	120	450	740	30	1,88	8,33	WGRE1080050
1170	504	450	216	116	200	450	1110	30	2,71	11,19	WGRE1117050
1540	504	450	284	151	300	450	1480	30	3,54	14,05	WGRE1154050



 colour included in the price

Technical drawing:

SX

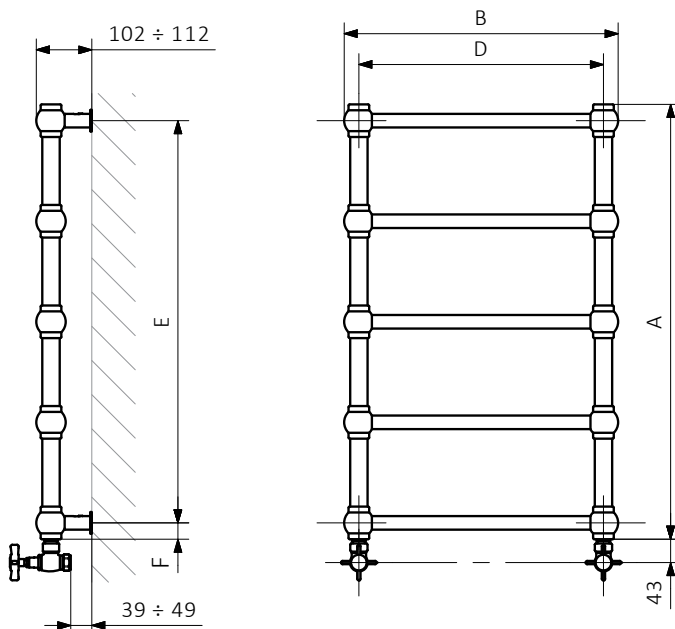
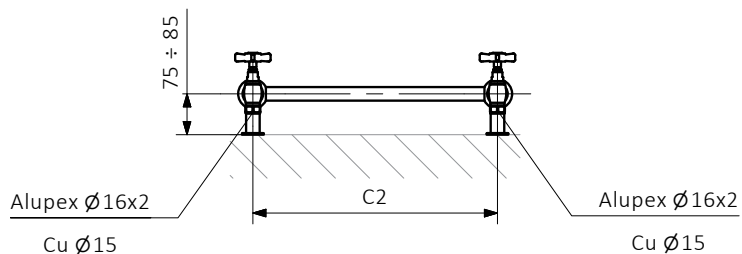

A – Height B – Width C1-C5 – Distance between pipe centres D – Horizontal distance between mounting bracket centres
E – Vertical distance between mounting brackets F – Distance between a mounting bracket and the bottom of the radiator

Collector:

Pipe:

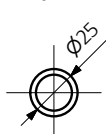
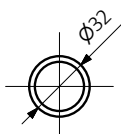

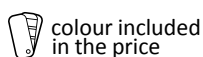

colour included
in the price

In the table with technical data, the last column lists product codes. When placing an order, please remember to quote the product code followed by the configuration code as shown in the diagram below:

The construction of a water and dual fuel radiator product and configuration code:

WGRE1043050

K916SX

PRODUCT CODE

(located in the table for the product)

CONFIGURATION CODE

(supplemented by hand)

Example Configuration

K 916 SX

Package code

K - carton box

Colour code

Connection code

Construction of electric heater configuration code:

WLRE1043050

K916E1DRYW

PRODUCT CODE

(located in the table for the product)

CONFIGURATION CODE

(supplemented by hand)

Example Configuration

K 916 E1 DRY W

Package code

K - carton box

Colour code

Connection code

Heating element code

Type of heating element cable code

Epoxy primer

E - Code of epoxy primer is an extra processes.

WGRE1043050 K916SX **E** — Extra processes or additions code

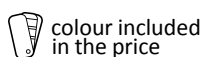

Legend



Radiator available in a "water" version.



Radiator suitable for dual fuel connection. Electric heating element can be installed.



Radiator available in electric only version. It comes prefilled with a 'heating medium' and equipped with a heating element. All tested and ready to use.



Connection types dedicated for this radiator. The icon shows the flow and return connections for the radiator as well as the thermostatic valve and heating element position if applicable.



Suggested heating element power output for electric and dual fuel versions.



Weight.



Capacity.



Available in chrome finish.



No additional payment for a color.