

Tune HSD

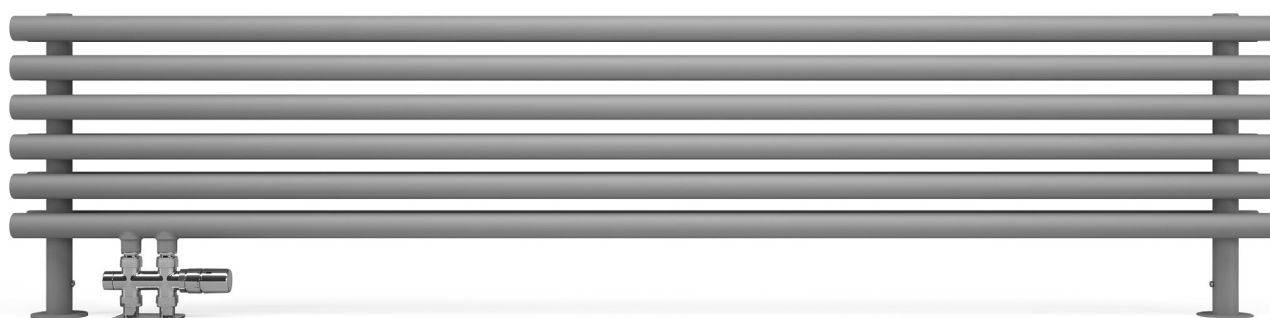

colour included
in the price



Tune HSD 390↑ × 1400↔ YL
colour: Silver Matt

Inline integrated thermostatic valve set, left, chrome
Integrated pipe-masking set, chrome

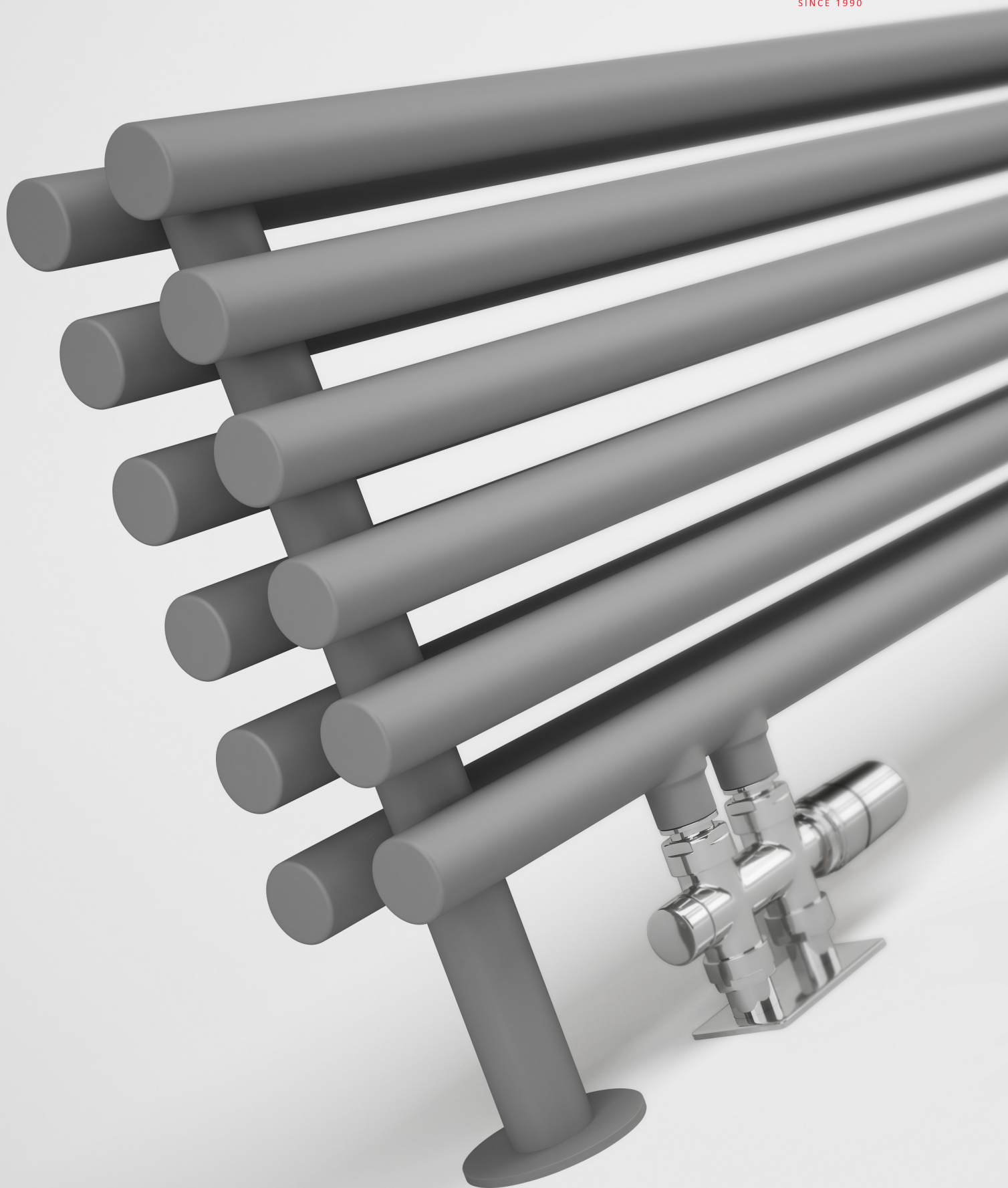

Tune HSD



colour included
in the price

Projekt : *Terma*

Standard connection:

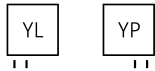

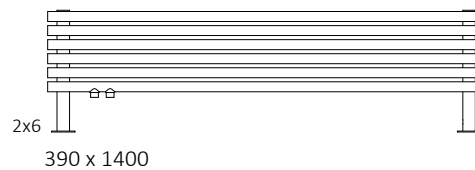
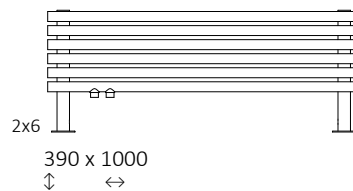
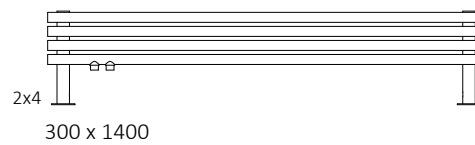
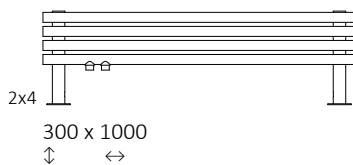

Available sizes:



Specification:

Working pressure: 1000 kPa Maximum operating temperature: 95°C

A ↓ [mm]	B ↔ [mm]	C1 [mm]	75/65/20°C [W]	55/45/20°C [W]	D [mm]	 [dm ³]	 [kg]	Product code <small>Configuration code p. 5</small>
300	1000	50	421	229	900	6,11	9,30	WGTUH030100
300	1400	50	589	320	1300	8,32	12,34	WGTUH030140
390	1000	50	564	305	900	9,05	13,58	WGTUH039100
390	1400	50	790	428	1300	12,35	18,15	WGTUH039140



colour included
in the price

Technical drawing:

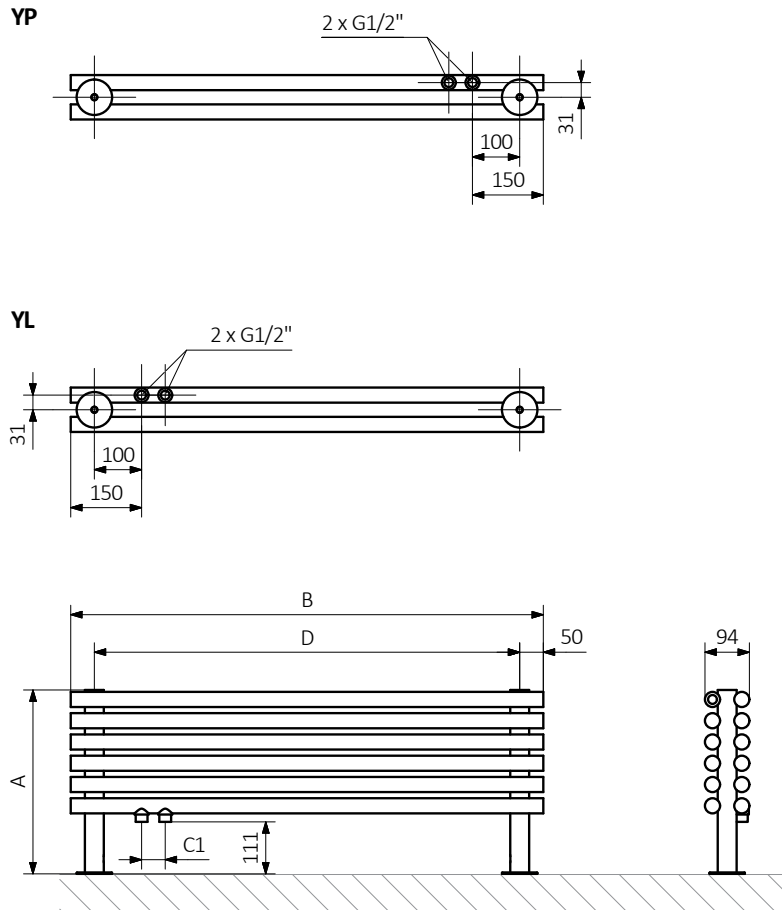

A – Height B – Width C1-C5 – Distance between pipe centres D – Horizontal distance between mounting bracket centres
E – Vertical distance between mounting brackets F – Distance between a mounting bracket and the bottom of the radiator

Collector :

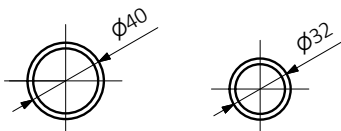



colour included
in the price

In the table with technical data, the last column lists product codes. When placing an order, please remember to quote the product code followed by the configuration code as shown in the diagram below:

The construction of a water and dual fuel radiator product and configuration code:

WGTUH030100

K916YL

PRODUCT CODE
(located in the table for the product)

CONFIGURATION CODE
(supplemented by hand)

Example Configuration

K **916** **YL**

Package code

Colour code

Connection code

K - carton box

Epoxy primer

E – Code of epoxy primer is an extra processes.

WGTUH030100 K916YL **E** — *Extra processes or additions code*



Legend



Radiator available in a "water" version.



Radiator suitable for dual fuel connection. Electric heating element can be installed.



Radiator available in electric only version. It comes prefilled with a 'heating medium' and equipped with a heating element. All tested and ready to use.



Connection types dedicated for this radiator. The icon shows the flow and return connections for the radiator as well as the thermostatic valve and heating element position if applicable.



Suggested heating element power output for electric and dual fuel versions.



Weight.



Capacity.



Available in chrome finish.



No additional payment for a color.