



▲ **Radiator**

Plain Towel Rail standing version 900 ↓ x 650 ↔ AX,  
colour: galvanic copper, frame colour: chrome  
configuration code: WGNTR090065 LGC5AX

**Valves and accessories**

Angled regulating valve set Star, chrome  
Pipe cover and shroud set – 160 mm, chrome

**192 RAL COLORS AND PALETTE  
FINISHING OF CAST RADIATORS**



# PLAIN TOWEL RAIL





▲ Radiator

Plain Towel Rail standing version 900 ↓ x 490 ↔ AX,  
colour: flat black, frame colour: antique brass  
configuration code: WGNTR090049 LFB3AXAN5

Valves and accessories

Angled regulating valve set Minimalist, chrome  
Pipe cover and shroud set – 160 mm, chrome

192 RAL COLORS AND PALETTE  
FINISHING OF CAST RADIATORS



# PLAIN TOWEL RAIL







AVAILABLE SIZES

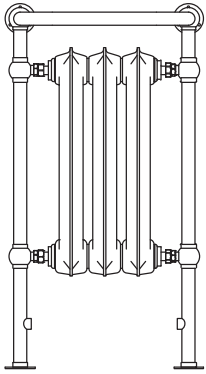

900 x 490  
↑ ↓   ← →

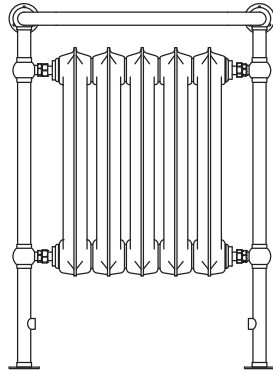

900 x 650

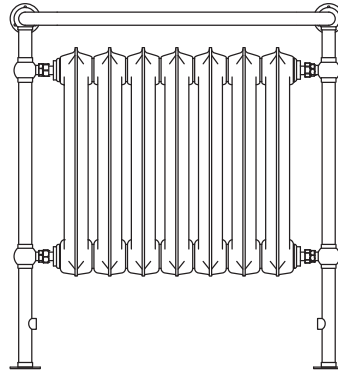

900 x 820

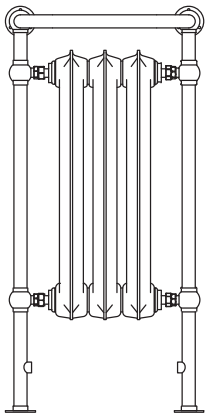

1000 x 490

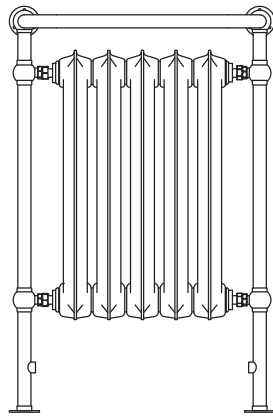

1000 x 650

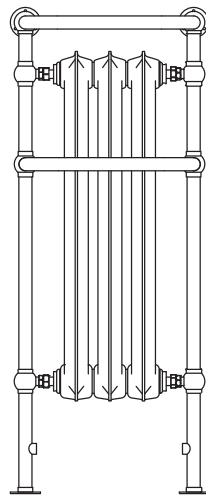

1200 x 490

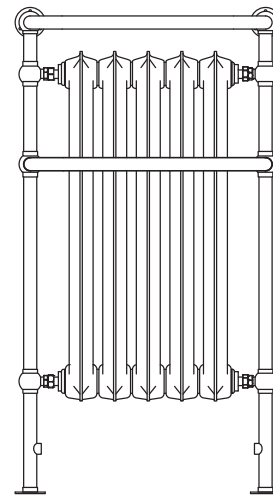

1200 x 650

## EFFICIENCY

## CENTRAL HEATING

Connections:



Height A ↕ [mm]	Width B ↔ [mm]	Heating power		Product code ... Configuration p.8
		75/65/20°C [W]	55/45/20°C [W]	
900	490	357	190	WGNTR090049...
900	650	595	317	WGNTR090065...
900	820	834	445	WGNTR090082...
1000	490	416	221	WGNTR100049...
1000	650	694	368	WGNTR100065...
1200	490	619	324	WGNTR120049...
1200	650	1031	539	WGNTR120065...

## WYMIARY I INFORMACJE TECHNICZNE

Working pressure: 1000 kPa

Maximum operating temperature: 95°C

Height A ↕ [mm]	Width B ↔ [mm]	Spacing connection C4 [mm]	D [mm]	D1 [mm]	D2 [mm]	Capacity	Weight
						[dm³]	[kg]
900	490	366	—	—	—	9,62	37.00
900	650	530	—	—	—	14,93	55.00
900	820	694	—	—	—	20,24	73.00
1000	490	366	—	—	—	11,06	40.00
1000	650	530	—	—	—	17,37	61.00
1200	490	366	—	—	—	15,02	50.00
1200	650	530	—	—	—	23,60	73.00

TECHNICAL DRAWING

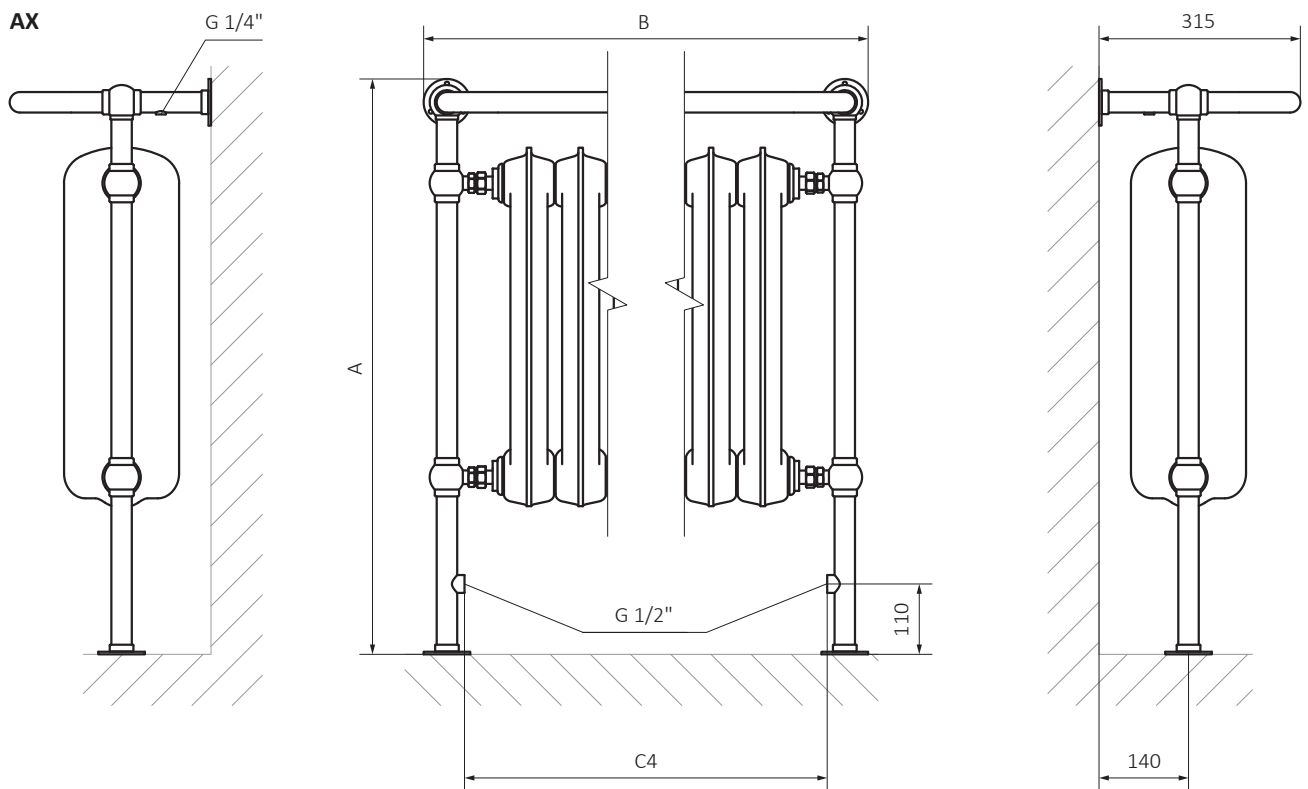

A – Height B – Width C4 – Distance between pipe centres

Product codes can be found in the product tables in both the catalogue and the price list. They provide basic information about the product and the configuration code contains information that complements the specification. When placing an order, the product codes should contain the fully completed configuration part. Part of the configuration code should be placed after the main product code as shown in the example below:

## A CONFIGURATION CODE FOR PLAIN TOWEL RAIL RADIATOR WITH CHROME-PLATED FRAME (WG PRODUCT GROUP)

### CODE DETAILS:

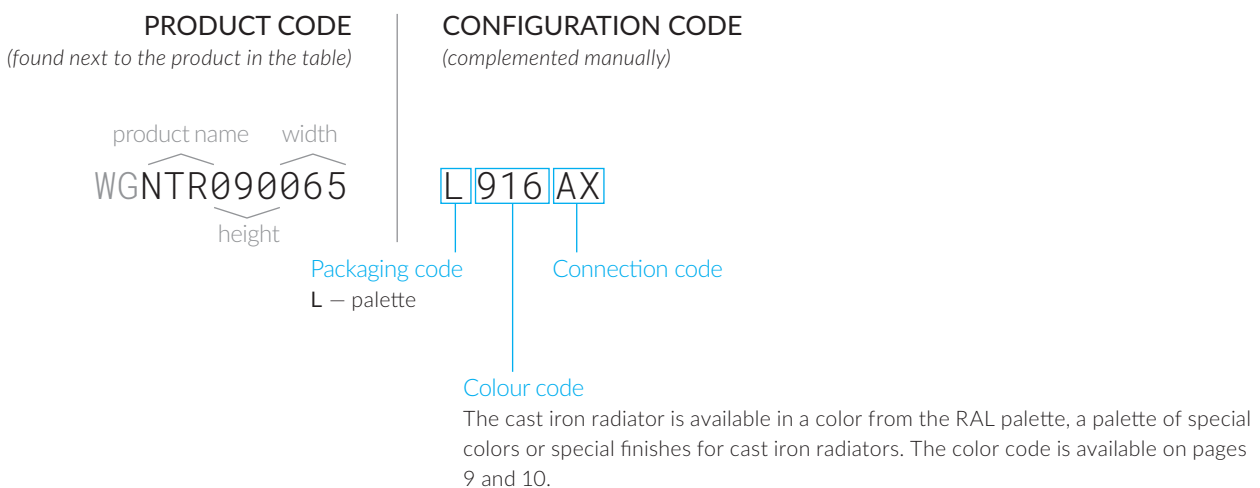

## A CONFIGURATION CODE FOR PLAIN TOWEL RAIL RADIATOR WITH PAINTED FRAME (WG PRODUCT GROUP)

### CODE DETAILS:

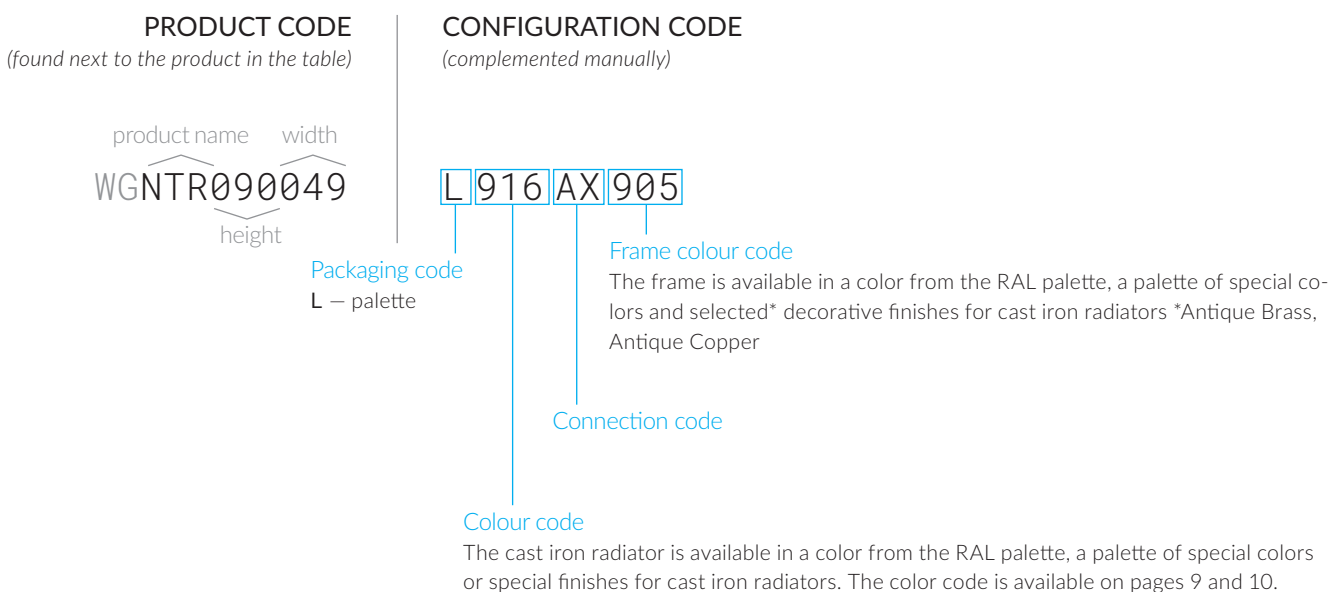



## RANGE OF FINISHES FOR CAST IRON RADIATORS

In addition to the palette of 192 standard RAL colors (liquid painting), we offer a palette of special colors and a range of decorative finishes. At the customer's special request, we also prepare radiators and accessories in individually selected finishes.

### SPECIAL COLOURS PALETTE

#### GROUP 1



PALETA RAL

#### GROUP 2

































































































































































































#### GROUP 3



\* the base colour for the ornament can be any colour from the Group 1 palette

## RAL COLOUR PALETTE

 100 – RAL 1000	 302 – RAL 3002	 511 – RAL 5011	 627 – RAL 6027	 745 – RAL 7045
 101 – RAL 1001	 303 – RAL 3003	 512 – RAL 5012	 628 – RAL 6028	 746 – RAL 7046
 102 – RAL 1002	 304 – RAL 3004	 513 – RAL 5013	 629 – RAL 6029	 747 – RAL 7047
 103 – RAL 1003	 305 – RAL 3005	 514 – RAL 5014	 632 – RAL 6032	 800 – RAL 8000
 104 – RAL 1004	 307 – RAL 3007	 515 – RAL 5015	 633 – RAL 6033	 801 – RAL 8001
 105 – RAL 1005	 309 – RAL 3009	 517 – RAL 5017	 634 – RAL 6034	 802 – RAL 8002
 106 – RAL 1006	 311 – RAL 3011	 518 – RAL 5018	 700 – RAL 7000	 803 – RAL 8003
 107 – RAL 1007	 312 – RAL 3012	 519 – RAL 5019	 701 – RAL 7001	 804 – RAL 8004
 111 – RAL 1011	 313 – RAL 3013	 520 – RAL 5020	 702 – RAL 7002	 807 – RAL 8007
 112 – RAL 1012	 314 – RAL 3014	 521 – RAL 5021	 703 – RAL 7003	 808 – RAL 8008
 113 – RAL 1003	 315 – RAL 3015	 522 – RAL 5022	 704 – RAL 7004	 811 – RAL 8011
 114 – RAL 1014	 316 – RAL 3016	 523 – RAL 5023	 705 – RAL 7005	 812 – RAL 8012
 115 – RAL 1015	 317 – RAL 3017	 524 – RAL 5024	 706 – RAL 7006	 814 – RAL 8014
 116 – RAL 1016	 318 – RAL 3018	 600 – RAL 6000	 708 – RAL 7008	 815 – RAL 8015
 117 – RAL 1017	 320 – RAL 3020	 601 – RAL 6004	 709 – RAL 7009	 816 – RAL 8016
 118 – RAL 1018	 322 – RAL 3022	 602 – RAL 6002	 710 – RAL 7010	 817 – RAL 8017
 119 – RAL 1019	 327 – RAL 3027	 603 – RAL 6003	 711 – RAL 7011	 819 – RAL 8019
 120 – RAL 1020	 328 – RAL 3028	 604 – RAL 6004	 712 – RAL 7012	 822 – RAL 8022
 121 – RAL 1021	 331 – RAL 3031	 605 – RAL 6005	 713 – RAL 7013	 823 – RAL 8023
 123 – RAL 1023	 401 – RAL 4001	 606 – RAL 6006	 715 – RAL 7015	 824 – RAL 8024
 124 – RAL 1024	 402 – RAL 4002	 607 – RAL 6007	 716 – RAL 7016	 825 – RAL 8025
 127 – RAL 1027	 403 – RAL 4003	 608 – RAL 6008	 721 – RAL 7021	 828 – RAL 8028
 128 – RAL 1028	 404 – RAL 4004	 609 – RAL 6009	 722 – RAL 7022	 901 – RAL 9001
 132 – RAL 1032	 405 – RAL 4005	 610 – RAL 6010	 723 – RAL 7023	 902 – RAL 9002
 133 – RAL 1033	 406 – RAL 4006	 611 – RAL 6011	 724 – RAL 7024	 903 – RAL 9003
 134 – RAL 1034	 407 – RAL 4007	 612 – RAL 6012	 726 – RAL 7026	 904 – RAL 9004
 137 – RAL 1037	 408 – RAL 4008	 613 – RAL 6013	 730 – RAL 7030	 9M5 – RAL 9005
 200 – RAL 2000	 409 – RAL 4009	 614 – RAL 6014	 732 – RAL 7032	 906 – RAL 9006
 201 – RAL 2001	 410 – RAL 4010	 615 – RAL 6015	 733 – RAL 7033	 907 – RAL 9007
 202 – RAL 2002	 500 – RAL 5000	 616 – RAL 6016	 734 – RAL 7034	 910 – RAL 9010
 203 – RAL 2003	 501 – RAL 5001	 617 – RAL 6017	 735 – RAL 7035	 911 – RAL 9011
 204 – RAL 2004	 502 – RAL 5002	 618 – RAL 6018	 736 – RAL 7036	 916 – RAL 9016
 208 – RAL 2008	 503 – RAL 5003	 619 – RAL 6019	 737 – RAL 7037	 917 – RAL 9017
 209 – RAL 2009	 504 – RAL 5004	 620 – RAL 6020	 738 – RAL 7038	 918 – RAL 9018
 210 – RAL 2010	 505 – RAL 5005	 621 – RAL 6021	 739 – RAL 7039	
 211 – RAL 2011	 507 – RAL 5007	 622 – RAL 6022	 740 – RAL 7040	
 212 – RAL 2012	 508 – RAL 5008	 624 – RAL 6024	 742 – RAL 7042	
 300 – RAL 3000	 509 – RAL 5009	 625 – RAL 6025	 743 – RAL 7043	
 301 – RAL 3001	 510 – RAL 5010	 626 – RAL 6026	 744 – RAL 7044	