



Radiator

Free standing Kaszub 520↑ x 852↔ LP, colour: galvanic copper

Valves and accessories

Wood thermostatic angled valve set, brushed copper

Pipe masking set, brushed copper

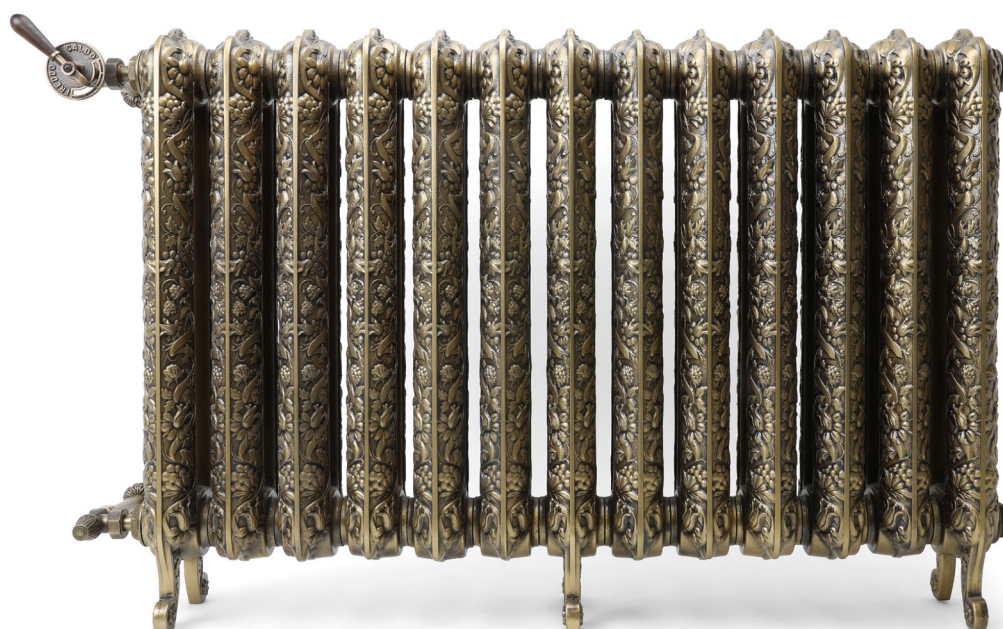

Radiator

Free standing Kaszub 720↑ x 1098↔ LP, colour: antique brass

Valves and accessories

Angled regulating valve set Classic Art, brushed bronze

Pipe cover and shroud set Artistic, brushed bronze

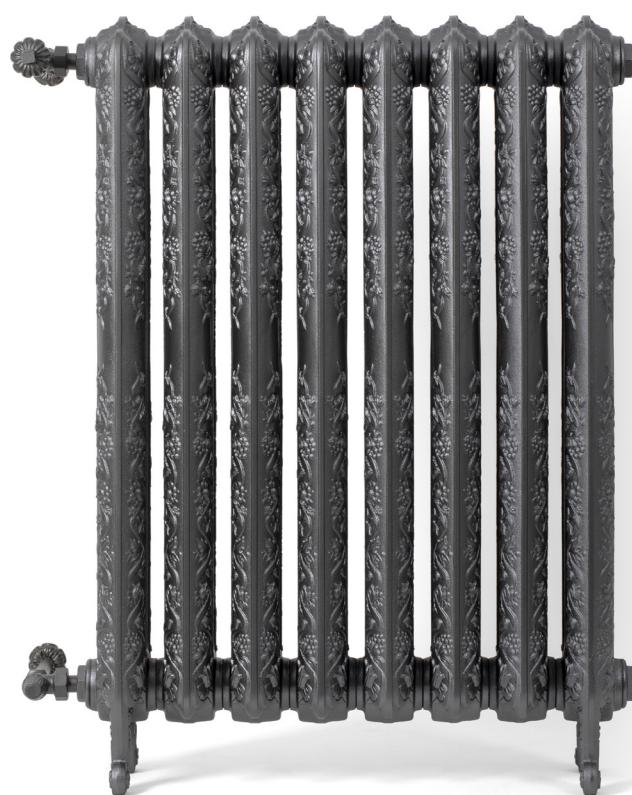

Radiator

Free standing Kaszub 920↑ x 688↔ LP, colour: raw metal

Valves and accessories

Angled regulating valve set Artistic, anthracite

Pipe cover and shroud set Artistic, anthracite

Kaszub



520 ⇅

Kaszub



720 ↓

Kaszub



920 ⇅



Standard connections:



Available sizes:

Wall mounted



460 x 80
1 section



460 x 278
3 sections



460 x 360
4 sections



460 x 442
5 sections



460 x 524
6 sections



460 x 606
7 sections



460 x 688
8 sections

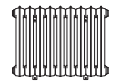

460 x 770
9 sections

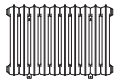

460 x 852
10 sections

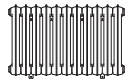

460 x 934
11 sections

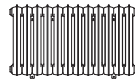

460 x 1016
12 sections

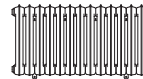

460 x 1098
13 sections

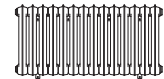

460 x 1180
14 sections

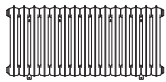

460 x 1262
15 sections

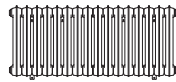

460 x 1344
16 sections

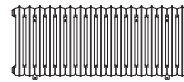

460 x 1426
17 sections



660 x 80
1 section

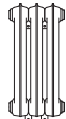

660 x 278
3 sections

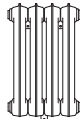

660 x 360
4 sections

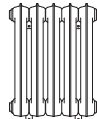

660 x 442
5 sections

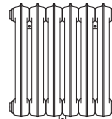

660 x 524
6 sections

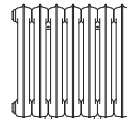

660 x 606
7 sections

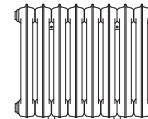

660 x 688
8 sections

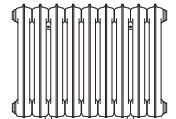

660 x 770
9 sections

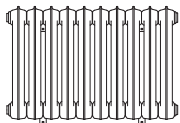

660 x 852
10 sections

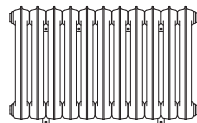

660 x 934
11 sections

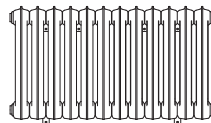

660 x 1016
12 sections

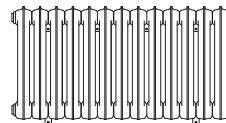

660 x 1098
13 sections

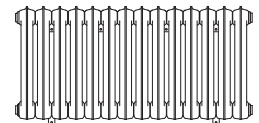

660 x 1180
14 sections

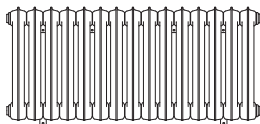

660 x 1262
15 sections

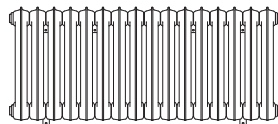

660 x 1344
16 sections

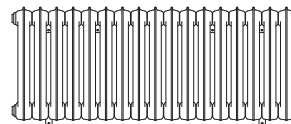

660 x 1426
17 sections



860 x 80
1 section

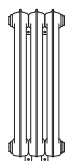

860 x 278
3 sections

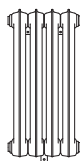

860 x 360
4 sections

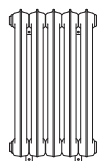

860 x 442
5 sections

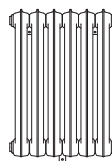

860 x 524
6 sections

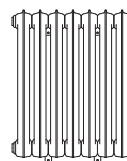

860 x 606
7 sections

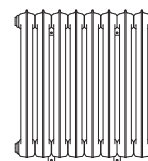

860 x 688
8 sections



860 x 770
9 sections

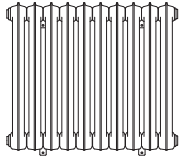

860 x 852
10 sections

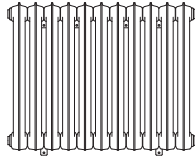

860 x 934
11 sections

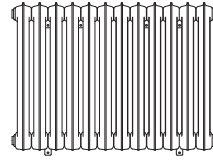

860 x 1016
12 sections

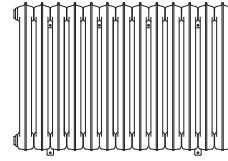

860 x 1098
13 sections

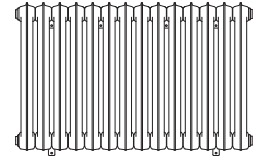

860 x 1180
14 sections

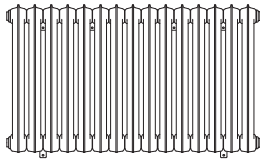

860 x 1262
15 sections

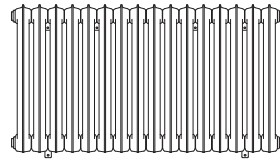

860 x 1344
16 sections

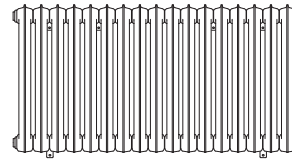

860 x 1426
17 sections

Free standing



520 x 80
1 section (1)



520 x 278
3 sections (2+1)



520 x 360
4 sections (2+2)



520 x 442
5 sections (2+3)



520 x 524
6 sections (2+4)



520 x 606
7 sections (2+5)

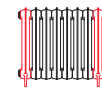

520 x 688
8 sections (2+6)

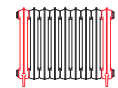

520 x 770
9 sections (2+7)

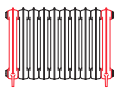

520 x 852
10 sections (2+8)

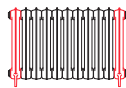

520 x 934
11 sections (2+9)

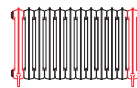

520 x 1016
12 sections (2+10)

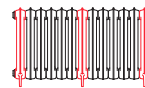

520 x 1098
13 sections (3+10)

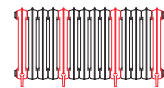

520 x 1180
14 sections (4+10)

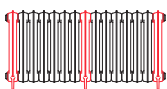

520 x 1262
15 sections (3+12)

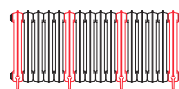

520 x 1344
16 sections (4+12)

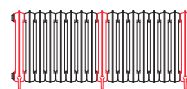

520 x 1426
17 sections (3+14)



720 x 80
1 section (1)



720 x 278
3 sections (2+1)

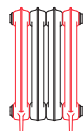

720 x 360
4 sections (2+2)

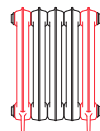

720 x 442
5 sections (2+3)

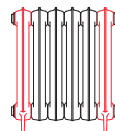

720 x 524
6 sections (2+4)

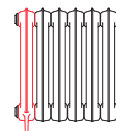

720 x 606
7 sections (2+5)

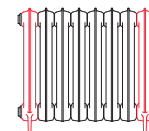

720 x 688
8 sections (2+6)

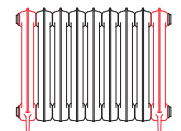

720 x 770
9 sections (2+7)

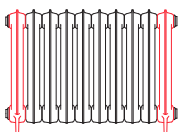

720 x 852
10 sections (2+8)

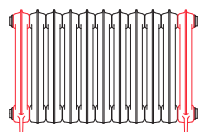

720 x 934
11 sections (2+9)

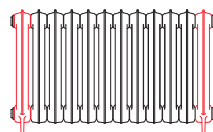

720 x 1016
12 sections (2+10)

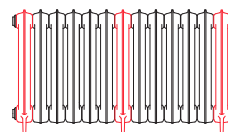

720 x 1098
13 sections (3+10)

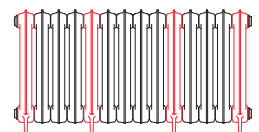

720 x 1180
14 sections (4+10)

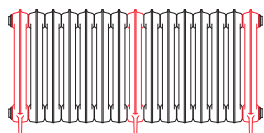

720 x 1262
15 sections (3+12)

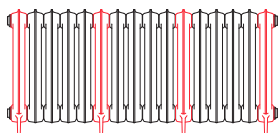

720 x 1344
16 sections (4+12)

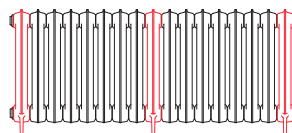

720 x 1426
17 sections (3+14)

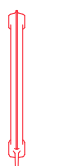

920 x 80
1 section (1)



920 x 278
3 sections (2+1)



920 x 360
4 sections (2+2)



920 x 442
5 sections (2+3)

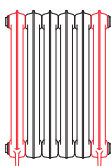

920 x 524
6 sections (2+4)

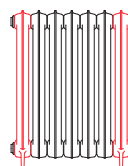

920 x 606
7 sections (2+5)

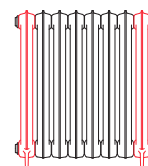

920 x 688
8 sections (2+6)

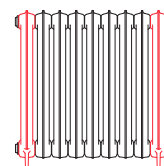

920 x 770
9 sections (2+7)

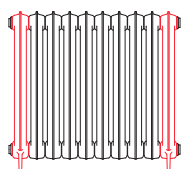

920 x 852
10 sections (2+8)

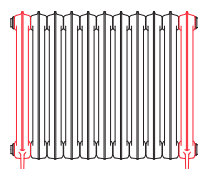

920 x 934
11 sections (2+9)

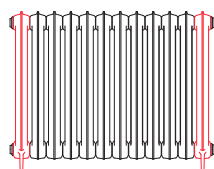

920 x 1016
12 sections (2+10)

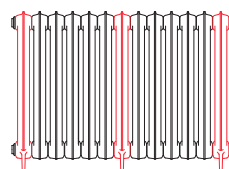

920 x 1098
13 sections (3+10)

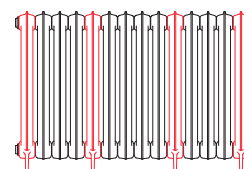

920 x 1180
14 sections (4+10)

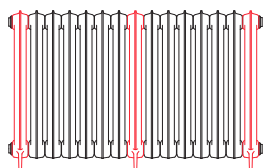

920 x 1262
15 sections (3+12)

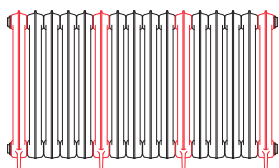

920 x 1344
16 sections (4+12)

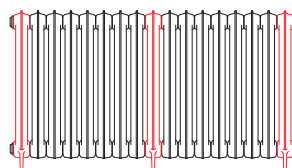

920 x 1426
17 sections (3+14)



Specifications:

Working pressure: 1000 kPa Maximum operating temperature: 95°C

A ↓ [mm]	B ↔ [mm]	C [mm]	75/65/20°C [W]	55/45/20°C [W]	D [mm]	D1 [mm]	D2 [mm]	H [dm³]	[kg]	Product code <small>(Configuration code p. 14)</small>
Wall mounted										
460	80	360	87	46	—	—	—	2,13	8,80	WGKAB046008
460	278	360	259	137	82	98	—	6,38	27,52	WGKAB046027
460	360	360	346	183	—	98	—	8,51	36,32	WGKAB046036
460	442	360	432	228	246	98	—	10,63	45,12	WGKAB046044
460	524	360	518	274	—	98	—	12,76	53,92	WGKAB046052
460	606	360	605	320	246	180	—	14,88	62,72	WGKAB046060
460	688	360	691	365	328	180	—	17,01	71,52	WGKAB046068
460	770	360	777	411	410	180	—	19,14	80,32	WGKAB046077
460	852	360	863	457	492	180	—	21,26	89,12	WGKAB046085
460	934	360	950	502	574	180	164	23,39	97,92	WGKAB046093
460	1016	360	1036	548	656	180	164	25,51	106,72	WGKAB046101
460	1098	360	1122	594	738	180	246	27,64	115,52	WGKAB046109
460	1180	360	1209	640	820	180	246	29,76	124,32	WGKAB046118
460	1262	360	1295	685	902	180	246	31,89	133,12	WGKAB046126
460	1344	360	1381	731	984	180	246	34,02	141,92	WGKAB046134
460	1426	360	1468	777	1066	180	246	36,14	150,72	WGKAB046142
660	80	560	120	65	—	—	—	3,05	10,8	WGKAB066008
660	278	560	361	195	82	98	—	9,16	33,5	WGKAB066027
660	360	560	481	260	—	98	—	12,21	44,3	WGKAB066036
660	442	560	602	325	246	98	—	15,27	55,1	WGKAB066044
660	524	560	722	391	—	98	—	18,32	65,9	WGKAB066052
660	606	560	842	456	246	180	—	21,37	76,7	WGKAB066060
660	688	560	962	521	—	180	—	24,42	87,5	WGKAB066068
660	770	560	1083	586	410	180	—	27,48	98,3	WGKAB066077
660	852	560	1203	651	492	180	—	30,53	109,1	WGKAB066085
660	934	560	1323	716	574	180	164	33,58	119,9	WGKAB066093
660	1016	560	1444	781	656	180	164	36,64	130,7	WGKAB066101
660	1098	560	1564	846	738	180	246	39,69	141,5	WGKAB066109
660	1180	560	1684	911	820	180	246	42,74	152,3	WGKAB066118
660	1262	560	1805	976	902	180	246	45,8	163,1	WGKAB066126
660	1344	560	1925	1041	984	180	246	48,85	173,9	WGKAB066134
660	1426	560	2045	1107	1066	180	246	51,9	184,7	WGKAB066142
860	80	760	149	80	-	—	—	4,14	14,0	WGKAB086008
860	278	760	447	239	82	98	—	12,42	43,1	WGKAB086027
860	360	760	596	318	-	98	—	16,56	57,1	WGKAB086036
860	442	760	745	398	246	98	—	20,70	71,1	WGKAB086044
860	524	760	894	477	-	98	—	24,84	85,1	WGKAB086052



A ↓ [mm]	B ↔ [mm]	C [mm]	75/65/20°C [W]	55/45/20°C [W]	D [mm]	D1 [mm]	D2 [mm]	U [dm³]	W [kg]	Product code <small>(Configuration code p. 14)</small>
860	606	760	1043	557	246	180	—	28,98	99,1	WGKAB086060
860	688	760	1192	636	328	180	—	33,12	113,1	WGKAB086068
860	770	760	1341	716	410	180	—	37,26	127,1	WGKAB086077
860	852	760	1490	795	492	180	—	41,40	141,1	WGKAB086085
860	934	760	1639	875	574	180	164	45,54	155,1	WGKAB086093
860	1016	760	1788	954	656	180	164	49,68	169,1	WGKAB086101
860	1098	760	1937	1034	738	180	246	53,82	183,1	WGKAB086109
860	1180	760	2086	1113	820	180	246	57,96	197,1	WGKAB086118
860	1262	760	2235	1193	902	180	246	62,10	211,1	WGKAB086126
860	1344	760	2384	1272	984	180	246	66,24	225,1	WGKAB086134
860	1426	760	2533	1352	1066	180	246	70,38	239,1	WGKAB086142

Radiators made up of 13 sections and more are delivered in two or more batteries.

Specifications:

Working pressure: 1000 kPa Maximum operating temperature: 95°C

A ↓ [mm]	B ↔ [mm]	C [mm]	75/65/20°C [W]	55/45/20°C [W]	D [mm]	D1 [mm]	D2 [mm]	U [dm³]	W [kg]	Product code <small>(Configuration code p. 14)</small>
Free standing										
520	80	360	86	46	—	—	—	2,57	9,30	WGKAF052008
520	278	360	259	137	—	—	—	6,71	29,02	WGKAF052027
520	360	360	345	183	—	—	—	8,28	37,92	WGKAF052036
520	442	360	432	228	—	—	—	10,85	46,82	WGKAF052044
520	524	360	518	274	—	—	—	12,42	55,72	WGKAF052052
520	606	360	604	320	—	—	—	14,99	64,62	WGKAF052060
520	688	360	690	365	—	—	—	17,56	73,52	WGKAF052068
520	770	360	777	411	—	—	—	19,13	82,42	WGKAF052077
520	852	360	863	457	—	—	—	21,00	91,32	WGKAF052085
520	934	360	949	502	—	—	—	23,27	100,22	WGKAF052093
520	1016	360	1036	548	—	—	—	25,84	109,12	WGKAF052101
520	1098	360	1122	594	—	—	—	27,41	118,62	WGKAF052109
520	1180	360	1208	640	—	—	—	29,98	128,12	WGKAF052118
520	1262	360	1295	685	—	—	—	31,55	136,42	WGKAF052126
520	1344	360	1381	731	—	—	—	34,12	145,92	WGKAF052134
520	1426	360	1467	777	—	—	—	36,69	154,22	WGKAF052142
720	80	560	120	65	—	—	—	3,05	11,3	WGKAF072008
720	278	560	360	195	—	—	—	9,16	35,1	WGKAF072027
720	360	560	480	260	—	—	—	12,21	46,1	WGKAF072036
720	442	560	600	325	—	—	—	15,27	57,1	WGKAF072044
720	524	560	720	390	—	—	—	18,32	68,1	WGKAF072052



A ↓ [mm]	B ↔ [mm]	C [mm]	75/65/20°C [W]	55/45/20°C [W]	D [mm]	D1 [mm]	D2 [mm]	H [dm ³]	⚖️ [kg]	Product code <small>(Configuration code p. 14)</small>
720	606	560	840	454	–	–	–	21,37	79,1	WGKAF072060
720	688	560	960	519	–	–	–	24,42	90,1	WGKAF072068
720	770	560	1080	584	–	–	–	27,48	101,1	WGKAF072077
720	852	560	1200	649	–	–	–	30,53	112,1	WGKAF072085
720	934	560	1320	714	–	–	–	33,58	123,1	WGKAF072093
720	1016	560	1440	779	–	–	–	36,64	134,1	WGKAF072101
720	1098	560	1560	844	–	–	–	39,69	145,6	WGKAF072109
720	1180	560	1680	909	–	–	–	42,74	157,1	WGKAF072118
720	1262	560	1800	974	–	–	–	45,8	167,6	WGKAF072126
720	1344	560	1920	1039	–	–	–	48,85	179,1	WGKAF072134
720	1426	560	2040	1104	–	–	–	51,9	189,6	WGKAF072142
920	80	760	149	80	–	–	–	4,14	15,0	WGKAF092008
920	278	760	447	239	–	–	–	12,42	45,7	WGKAF092027
920	360	760	596	318	–	–	–	16,56	59,9	WGKAF092036
920	442	760	745	398	–	–	–	20,70	74,1	WGKAF092044
920	524	760	894	477	–	–	–	24,84	88,3	WGKAF092052
920	606	760	1043	557	–	–	–	28,98	102,5	WGKAF092060
920	688	760	1192	636	–	–	–	33,12	116,7	WGKAF092068
920	770	760	1341	716	–	–	–	37,26	130,9	WGKAF092077
920	852	760	1490	795	–	–	–	41,40	145,1	WGKAF092085
920	934	760	1639	875	–	–	–	45,54	159,3	WGKAF092093
920	1016	760	1788	954	–	–	–	49,68	173,5	WGKAF092101
920	1098	760	1937	1034	–	–	–	53,82	188,7	WGKAF092109
920	1180	760	2086	1113	–	–	–	57,96	203,9	WGKAF092118
920	1262	760	2235	1193	–	–	–	62,10	217,1	WGKAF092126
920	1344	760	2384	1272	–	–	–	66,24	232,3	WGKAF092134
920	1426	760	2533	1352	–	–	–	70,38	245,5	WGKAF092142

Radiators made up of 13 sections and more are delivered in two or more batteries.



Wall mounted

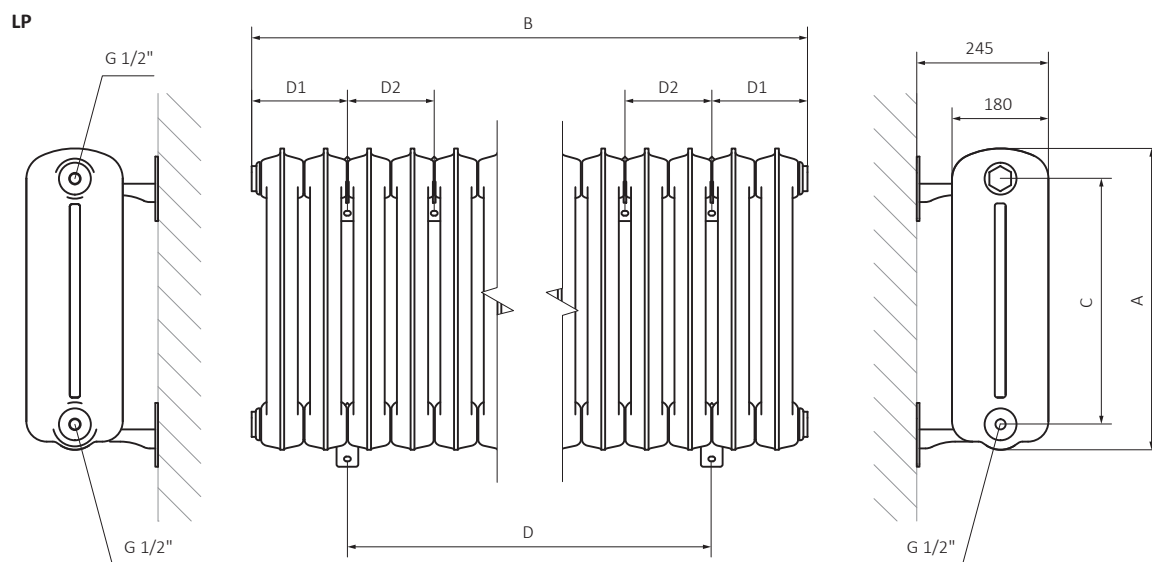

Free standing

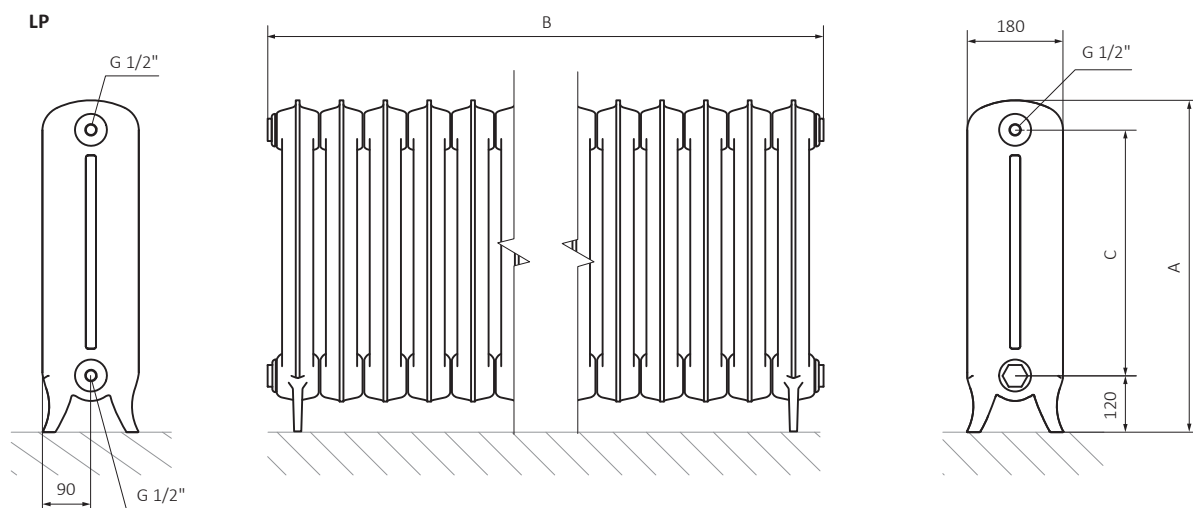

A – Height B – Width C – Distance between pipe centres D – Spacing of fixing hooks



Structure of configuration code for water and dual fuel radiators

Product codes can be found in product data sheet tables. The codes provide some basic information about the product while a partially filled configuration code contains complementary information about the detailed specifications. When placing an order, product codes should include the fully completed configuration part. The configuration code part should be placed after the main product code. The main product code and configuration part will appear as shown in the example below:

Code structure

WGKAF072109

L916LP

PRODUCT CODE

(located in the table for the product)

CONFIGURATION CODE

(supplemented by hand)

Configuration

