

# Felt composition 2

Product Fact Sheet



**ex.t**

info@ex-t.com / ex-t.com

# Felt composition 2



**Design By**  
Norm.Architects

**Code**  
EXFELTCOMB2  
EXFELTCOMB2BIANCO

**Category**  
Storage Units

**Module Dimensions**  
101.5 x 15 x h 59.5 cm

**Materials**  
Matt varnished metal

**Colours**

- Black - RAL 9004
- White - RAL 9016

**Weight**  
Product 12.7 kg  
Packaging kg

**Packaging Dimensions**  
-

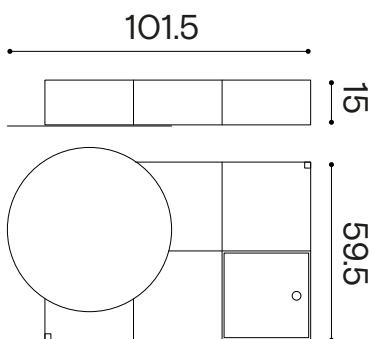

# Felt composition 2

Scale 1:10

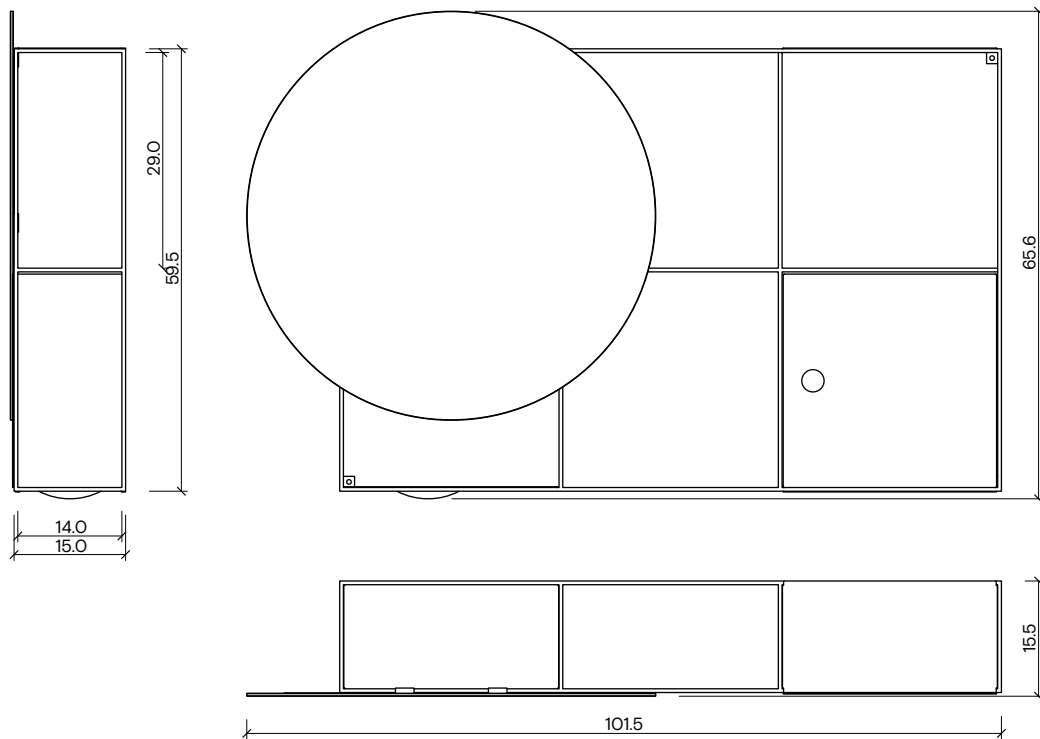

# GRID 3X2

EXFELTGRID3X2NE - EXFELTGRID3X2BI

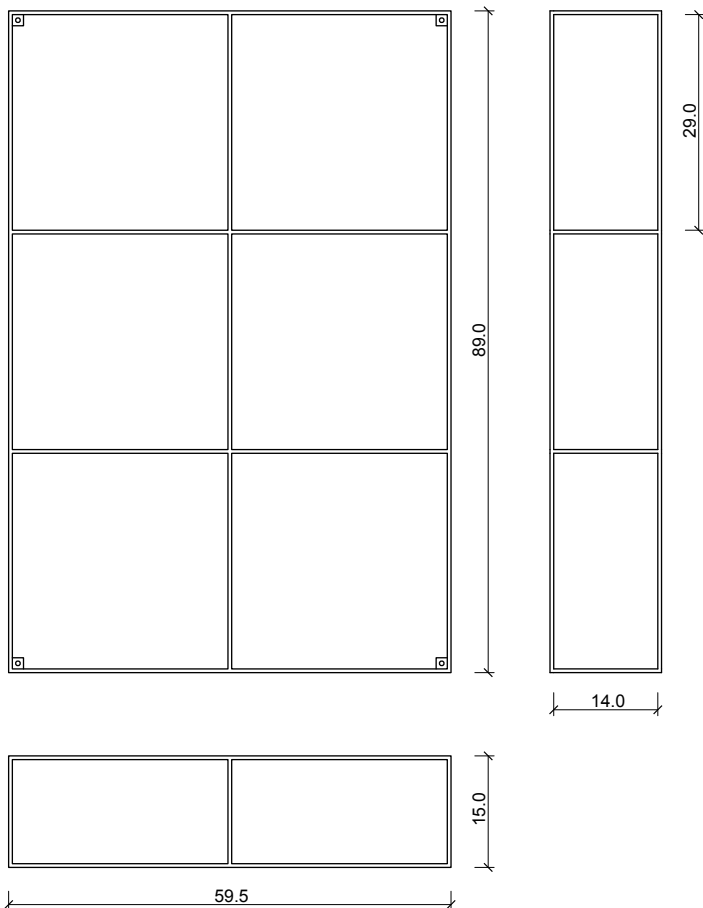

# TRAY

EXFELTGRIDVASNE - EXFELTGRIDVASBI

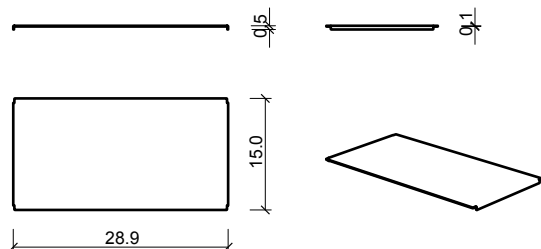

# ROUND MIRROR

EXFELTGRIDSPTOND

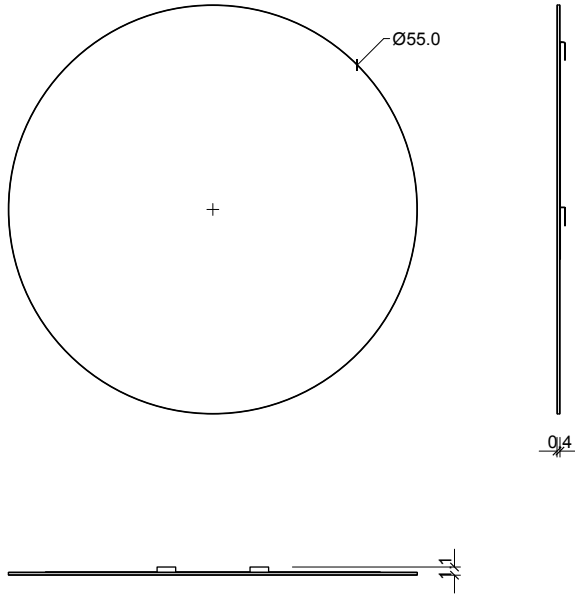

# CABINET

EXFELTGRIDCABNE - EXFELTGRIDCABBI

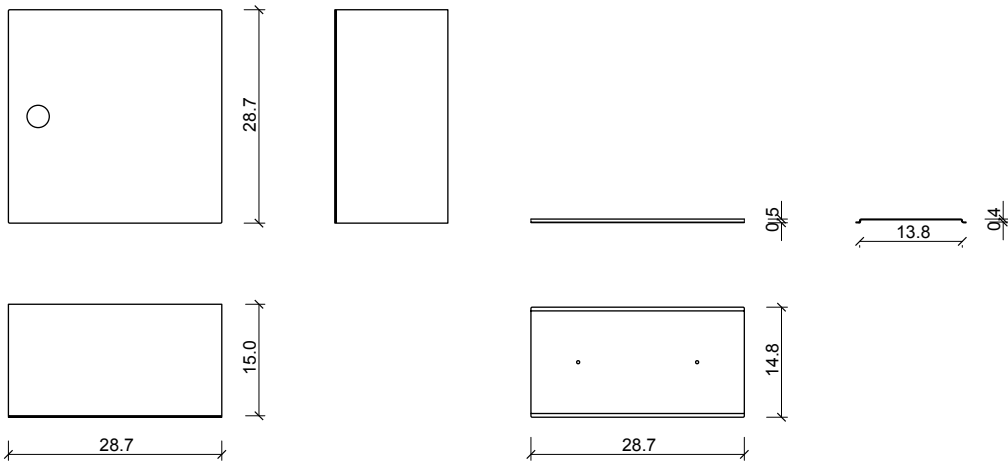

# TRAY WITH BOWL

EXFELTGRIDVASCIOOTNE

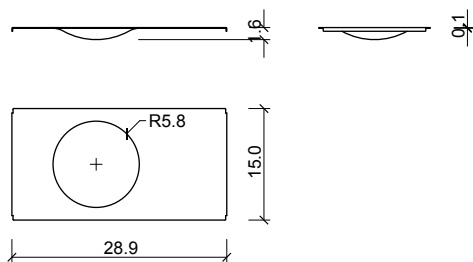

# TRAY

EXFELTGRIDVASNE - EXFELTGRIDVASBI

