

Pola One

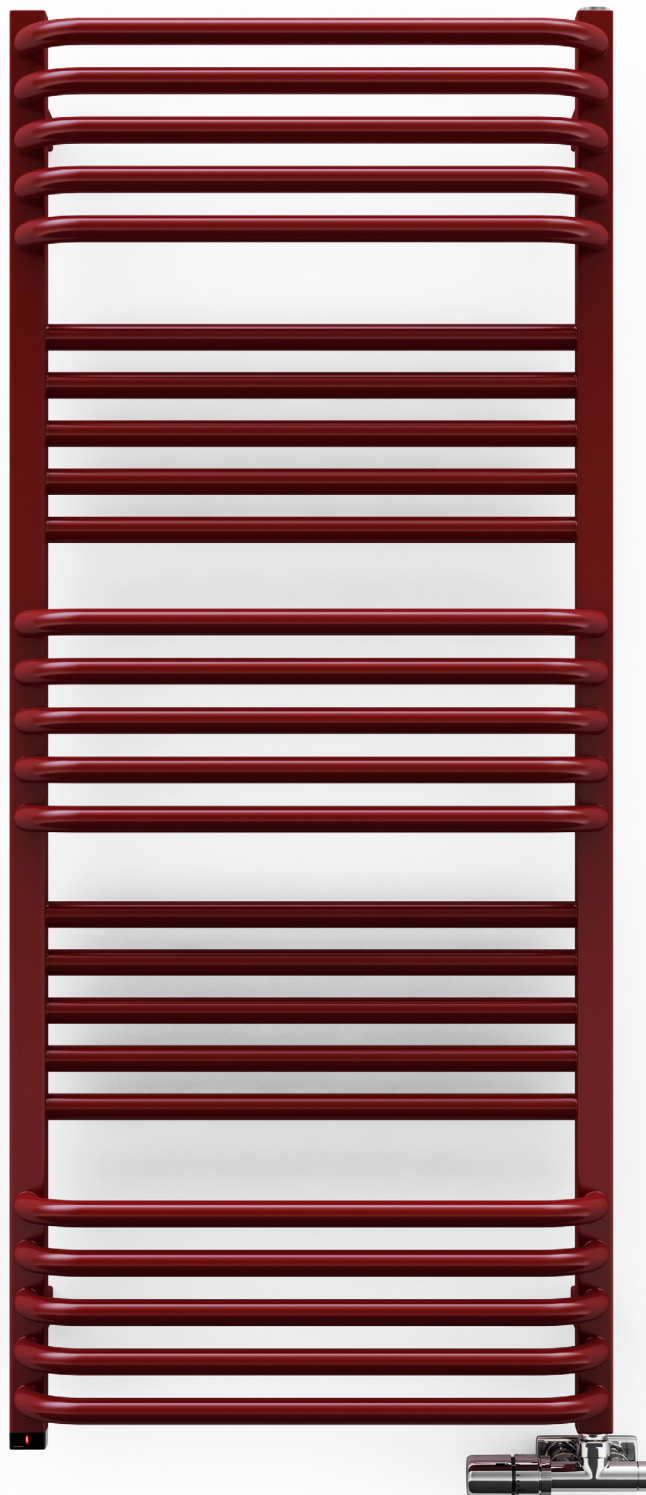

Pola One 1180↓ × 500↔ S1
colour: RAL 3004

Angled integrated thermostatic valve set with immersion tube, right, chrome
Integrated pipe-masking set, chrome
ONE heating element



Pola One



Design : Terma

Standard connection:

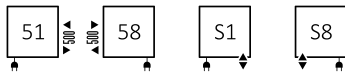

Optional connection:

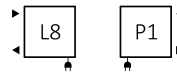

Electric radiators:

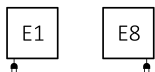

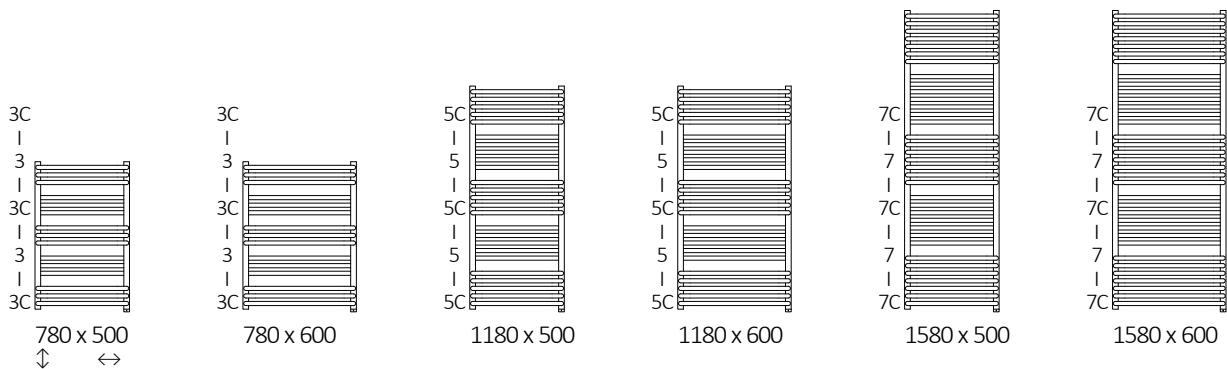

Available sizes:



Specification:

Working pressure: 1000 kPa Maximum operating temperature: 82°C

A ↓ [mm]	B ↔ [mm]	75/65/20°C [W]	55/45/20°C [W]	 [W]	D [mm]	E [mm]	F [mm]	 [dm³]	 [kg]	Product code <small>Configuration code p. 5</small>
Paint										
780	500	392	211	400	470	640	70	3,27	6,99	WZPAN078050
780	600	471	254	400	570	640	70	3,72	7,99	WZPAN078060
1180	500	638	342	600	470	1040	70	5,33	11,28	WZPAN118050
1180	600	766	411	800	570	1040	70	6,07	12,95	WZPAN118060
1580	500	883	473	800	470	1440	70	7,38	15,57	WZPAN158050
1580	600	1061	568	1000	570	1440	70	8,42	17,91	WZPAN158060
Plating										
780	500	274	140	300	470	640	70	3,27	6,72	WZPAN078050
780	600	330	168	300	570	640	70	3,72	7,68	WZPAN078060
1180	500	447	228	400	470	1040	70	5,33	10,84	WZPAN118050
1180	600	536	273	600	570	1040	70	6,07	12,44	WZPAN118060
1580	500	618	315	600	470	1440	70	7,38	14,96	WZPAN158050
1580	600	743	379	800	570	1440	70	8,42	17,20	WZPAN158060



Technical drawing:

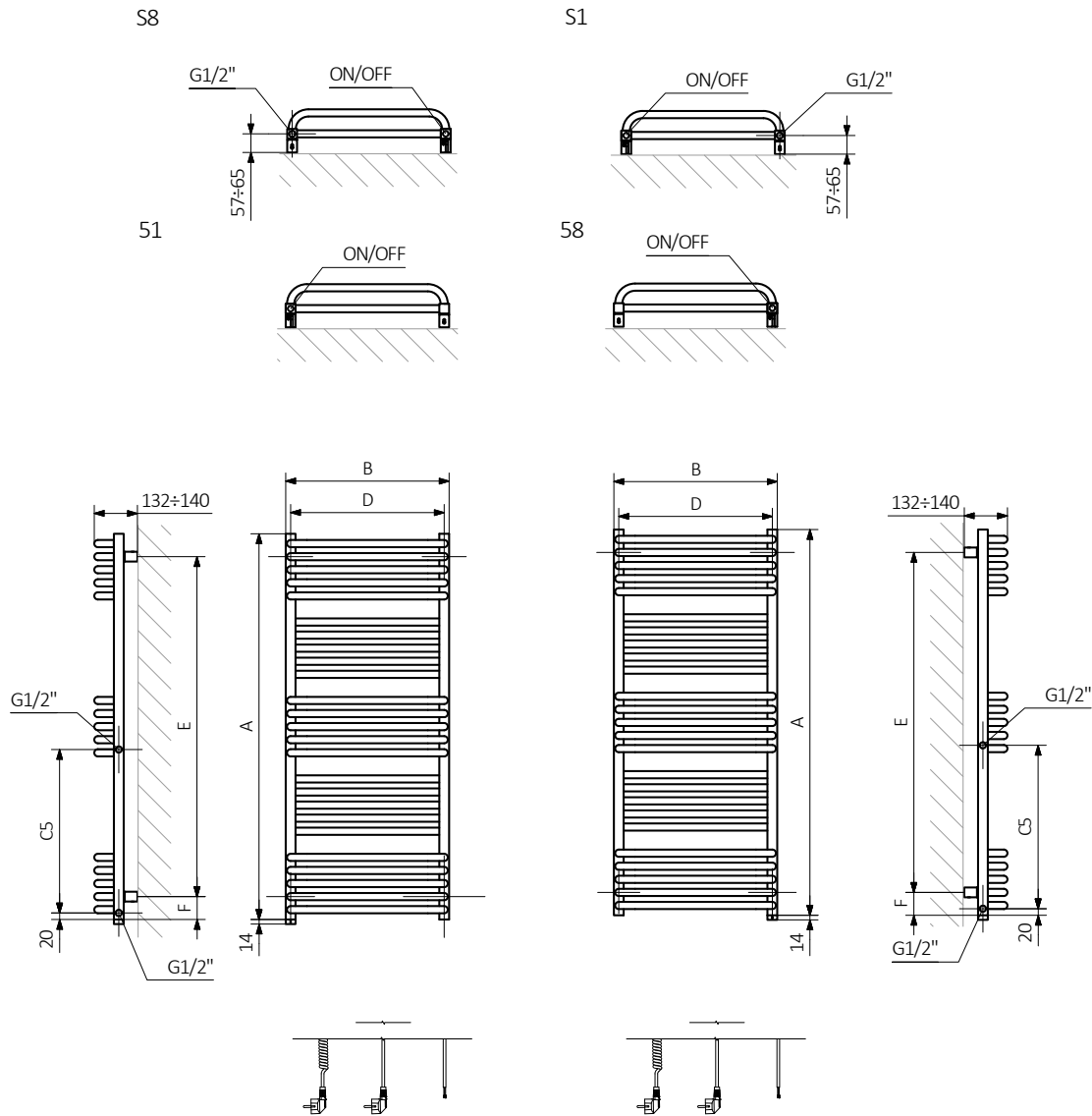

A – Height B – Width C1-C5 – Distance between pipe centres D – Horizontal distance between mounting bracket centres E – Vertical distance between mounting brackets F – Distance between a mounting bracket and the bottom of the radiator

Collector :

Pipe :

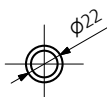
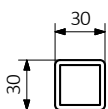



In the table with technical data, the last column lists product codes. When placing an order, please remember to quote the product code followed by the configuration code as shown in the diagram below:

The construction of a configuration code of a water radiator with a built-in One heating element:

WZPAN078050

PRODUCT CODE
(located in the table for the product)

K916S1

CONFIGURATION CODE
(supplemented by hand)

Cable Type

- W – straight cable with plug
- P – straight cable without plug
- U – spiral cable with plug

Example Configuration

K 916 S1 W

Package code Colour code Connection code Type of heating element cable code
K - carton box

The Construction of the product and configuration code for a radiator with the built-in heating element ONE:

WWPAN078050

PRODUCT CODE
(located in the table for the product)

K916E1

CONFIGURATION CODE
(supplemented by hand)

Cable Type

- W – straight cable with plug
- P – straight cable without plug
- U – spiral cable with plug

Example Configuration

K 916 E1 P

Package code Colour code Connection code Type of heating element cable code
K - carton box

Epoxy primer

E – Code of epoxy primer is an extra processes.

WZPAN078050 K916S1 **E** — Extra processes or additions code

Pola One



Legend



Radiator available in a "water" version.



Radiator suitable for dual fuel connection. Electric heating element can be installed.



Radiator available in electric only version. It comes prefilled with a 'heating medium' and equipped with a heating element. All tested and ready to use.



Connection types dedicated for this radiator. The icon shows the flow and return connections for the radiator as well as the thermostatic valve and heating element position if applicable.



Suggested heating element power output for electric and dual fuel versions.



Weight.



Capacity.



Available in chrome finish.



No additional payment for a color.