

STEINBERG



Unterputz Einbaukörper 1/2"

Art.Nr.039 4110

Installation

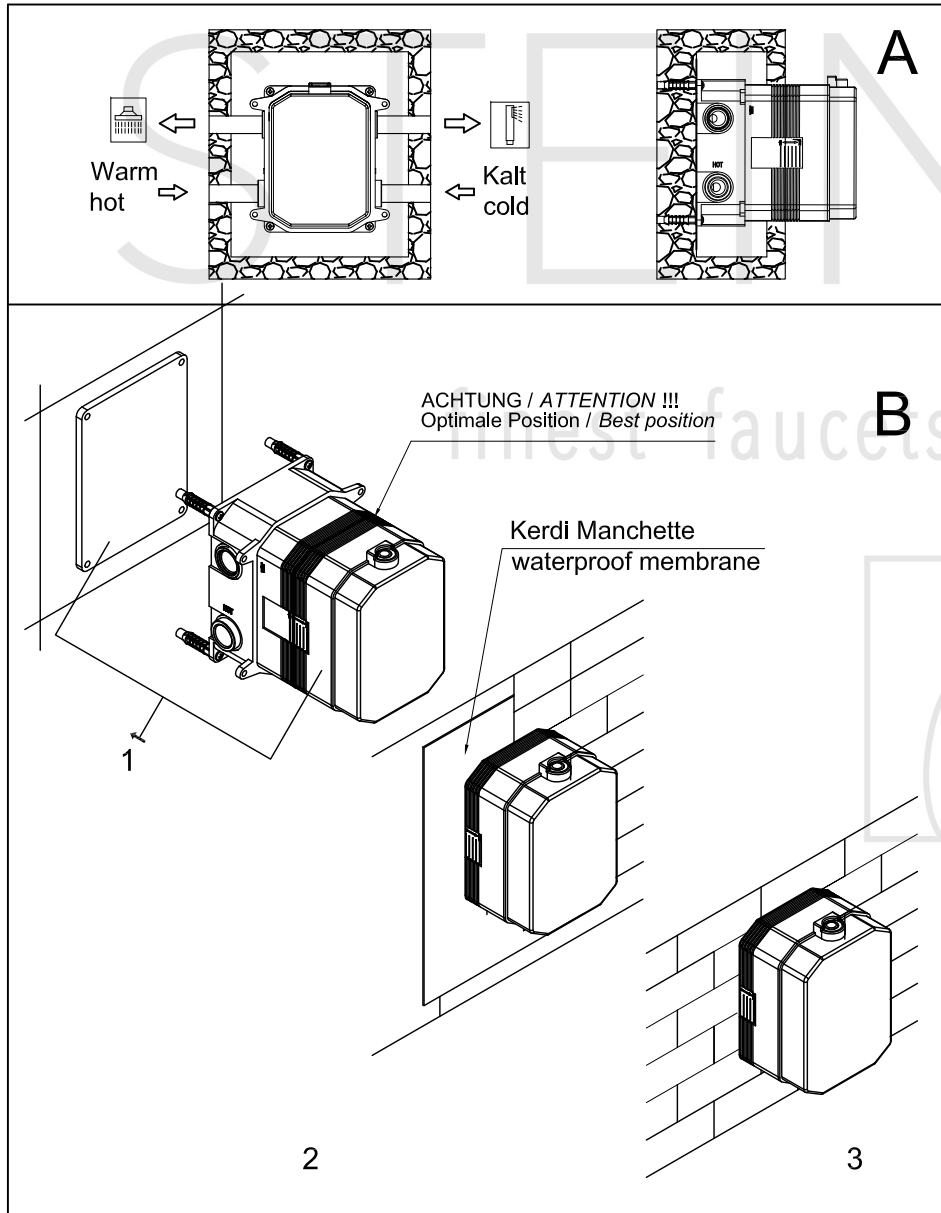

Technische Zeichnung

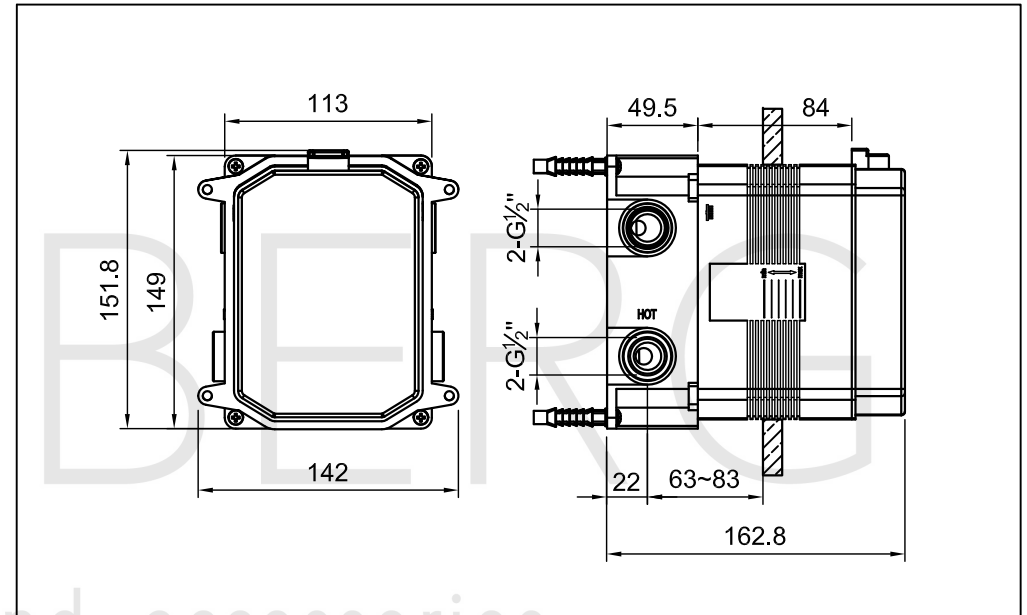

Explosionszeichnung

