

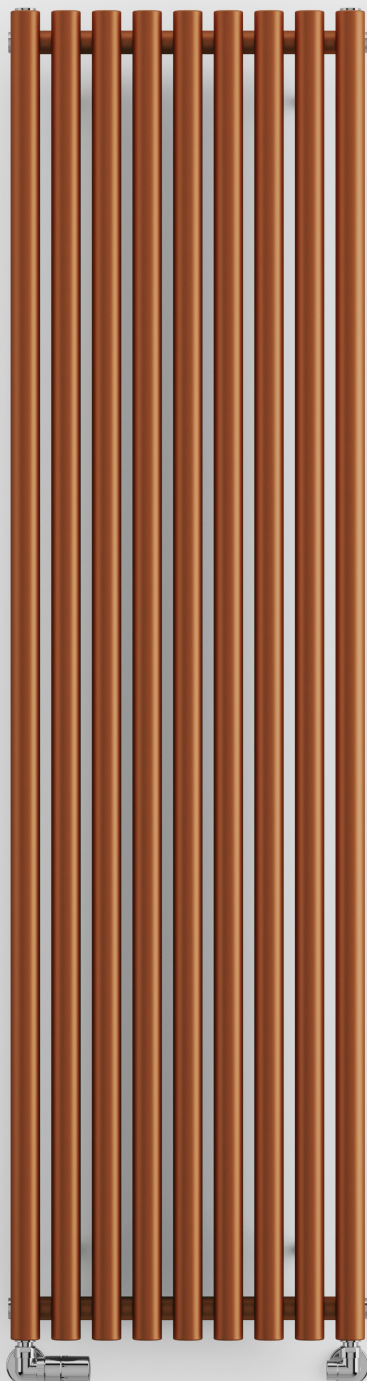

**TERMA**

SINCE 1990



◀ **Radiator**

ROLO ROOM 1800↑ x 480↔ SX,  
radiator colour: True Copper,  
radiator code: WGROR180048 KTCGSX

**Valves and accessories**

3-axis regulating valve set, chrome

**ROLO ROOM**



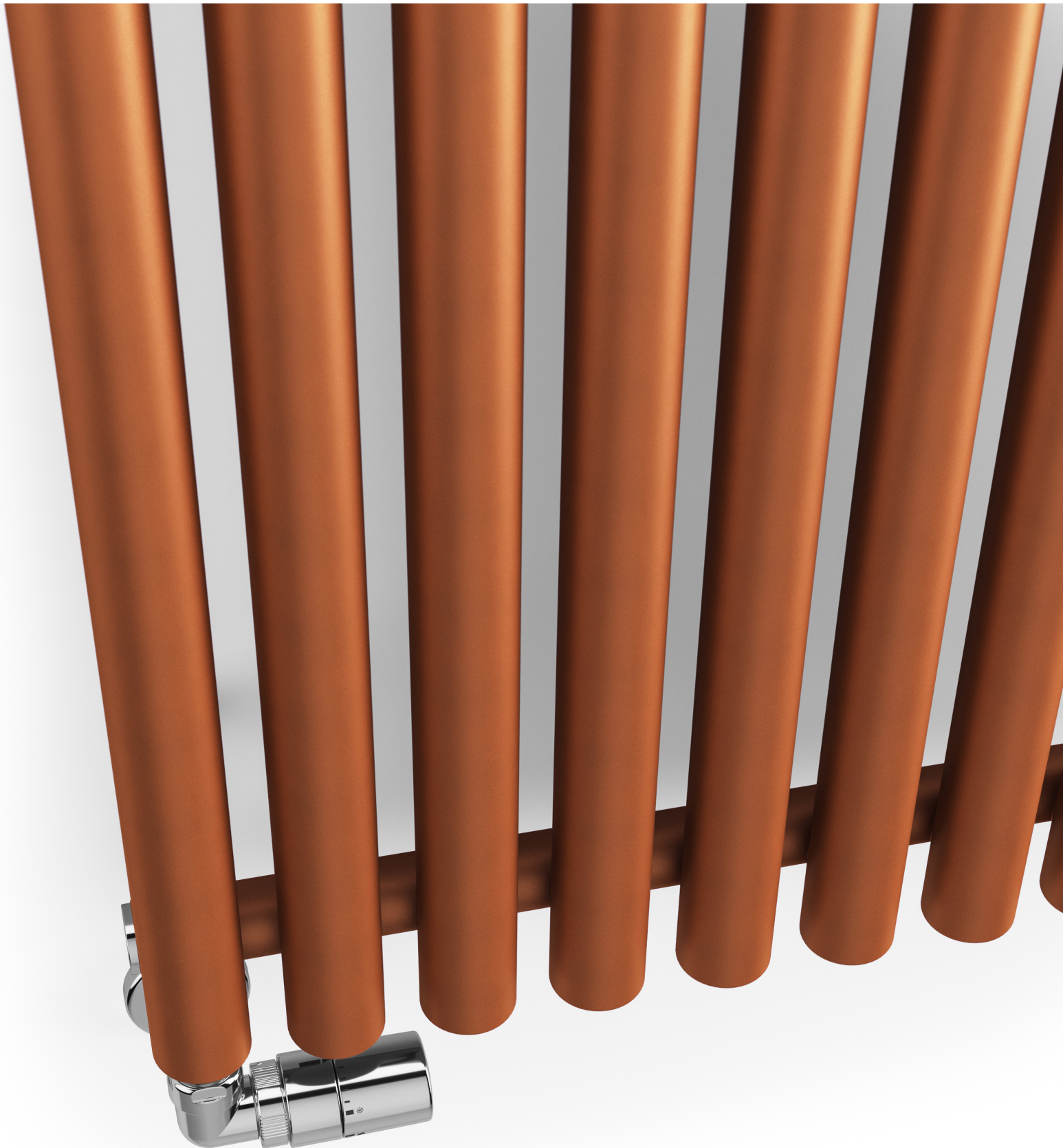

### AVAILABLE SIZES

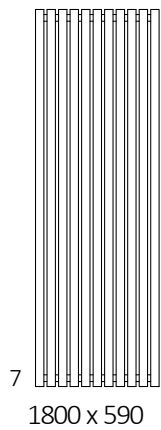
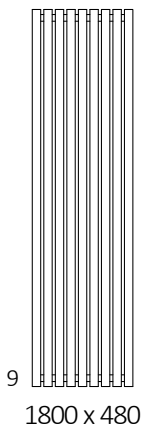
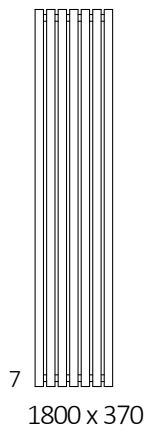
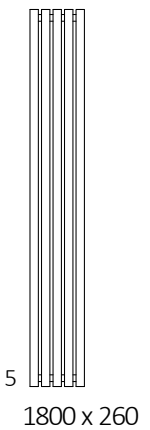
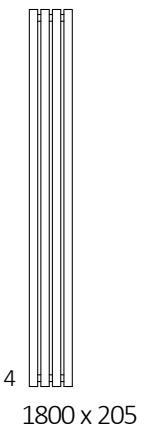
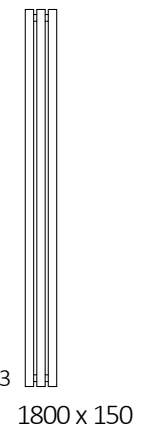
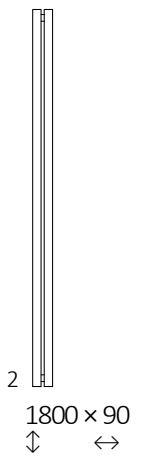
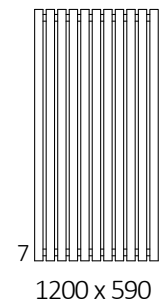
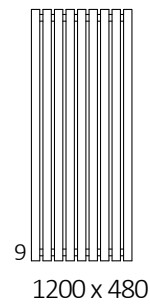
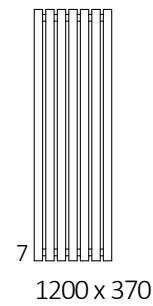
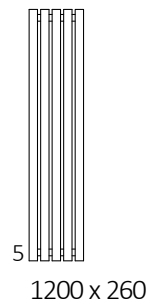
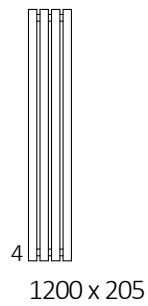
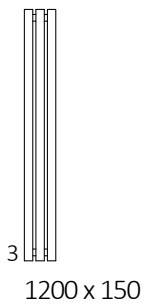
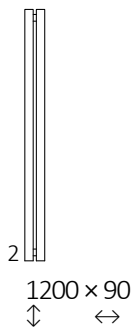
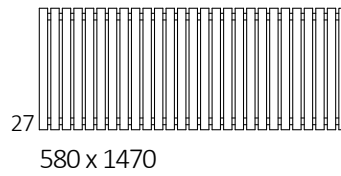
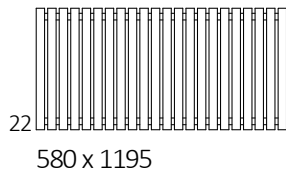
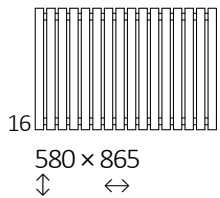
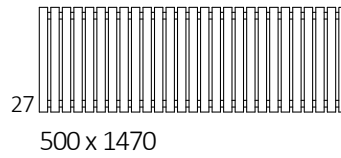
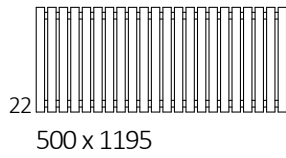
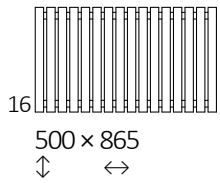

## CENTRAL HEATING

Connections

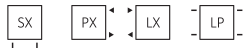



Height A ⇅ [mm]	Width B ↔ [mm]	Heating power			Product code <a href="#">... Configuration p.7</a>
		75/65/20°C [W]	55/45/20°C [W]	[W]	
500	865	591	310	600	WGROR050086
500	1195	812	426	800	WGROR050119
500	1470	997	523	1000	WGROR050147
580	865	672	334	800	WGROR058086
580	1195	924	459	1000	WGROR058119
580	1470	1134	563	1200	WGROR058147
1200	95	162	82	200	WGROR120009
1200	150	242	122	300	WGROR120015
1200	205	323	163	300	WGROR120020
1200	260	404	204	400	WGROR120026
1200	370	565	285	600	WGROR120037
1200	480	726	366	800	WGROR120048
1200	590	888	447	800	WGROR120059
1800	95	237	118	300	WGROR180009
1800	150	356	177	400	WGROR180010
1800	205	474	235	600	WGROR180020
1800	260	573	284	600	WGROR180026
1800	370	802	398	800	WGROR180037
1800	480	1031	512	1000	WGROR180048
1800	590	1260	625	1200	WGROR180059

## DIMENSIONS AND TECHNICAL INFORMATION

Working pressure: 1000 kPa

Maximum operating temperature: 95°C

Height A ⇅ [mm]	Width B ↔ [mm]	Spacing connection C2 [mm]	Spacing connection C3 [mm]	Spacing horizontal fasteners D [mm]	Spacing vertical fasteners E [mm]	Bottom fasteners position F [mm]	Capacity [dm³]	Weight [kg]
500	865	825	420	715	260	120	9,79	13,97
500	1195	1155	420	1045	260	120	13,47	19,23
500	1470	1430	420	1320	260	120	16,54	23,61
580	865	825	500	715	340	120	11,17	15,87
580	1195	1155	500	1045	340	120	15,36	21,83
580	1470	1430	500	1320	340	120	18,86	26,79

Height A ⇕ [mm]	Width B ↔ [mm]	Spacing connection C2 [mm]	Spacing connection C3 [mm]	Spacing horizontal fasteners D [mm]	Spacing vertical fasteners E [mm]	Bottom fasteners position F [mm]	Capacity  [dm³]	Weight  [kg]
1200	95	55	1120	55	960	120	2,71	3,99
1200	150	110	1120	110	960	120	4,08	5,90
1200	205	165	1120	165	960	120	5,44	7,81
1200	260	220	1120	220	960	120	6,81	9,51
1200	370	330	1120	330	960	120	9,54	13,33
1200	480	440	1120	440	960	120	12,27	17,15
1200	590	550	1120	550	960	120	15,00	20,97
1800	95	55	1720	55	1560	120	4,00	5,82
1800	150	110	1720	110	1560	120	6,01	8,66
1800	205	165	1720	165	1560	120	8,02	11,51
1800	260	220	1720	220	1560	120	10,03	13,94
1800	370	330	1720	330	1560	120	14,06	19,53
1800	480	440	1720	440	1560	120	18,08	25,12
1800	590	550	1720	550	1560	120	22,10	30,71

TECHNICAL DRAWING

SX

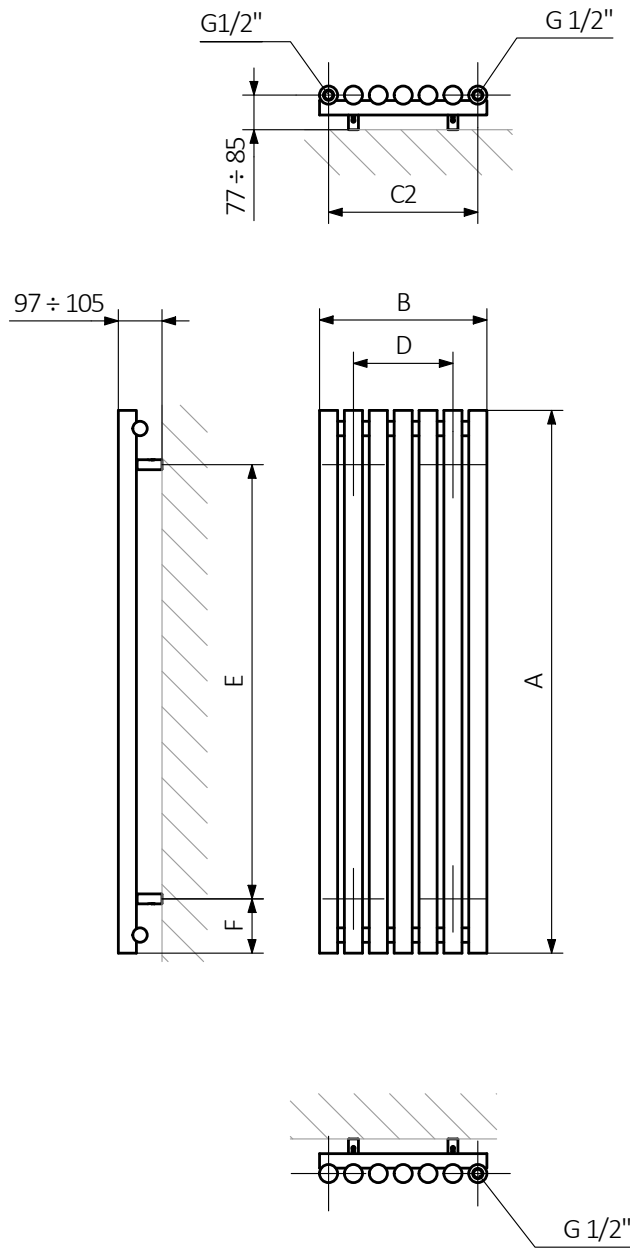

A – Height B – Width C1-C5 – Distance between pipe centres D – Horizontal distance between mounting bracket centres E – Vertical distance between mounting brackets F – Distance between a mounting bracket and the bottom of the radiator

**Collector: Pipe:**

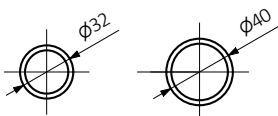

## CONFIGURATION CODE FOR A TOWEL RAIL OR RADIATOR ("WG" PRODUCT GROUP)

Product codes can be found in the product tables in both the catalogue and the price list. They provide basic information about the product and the configuration code contains information that complements the specification. When placing an order, the product codes should contain the fully completed configuration part. Part of the configuration code should be placed after the main product code as shown in the example below:

### CODE DETAILS:

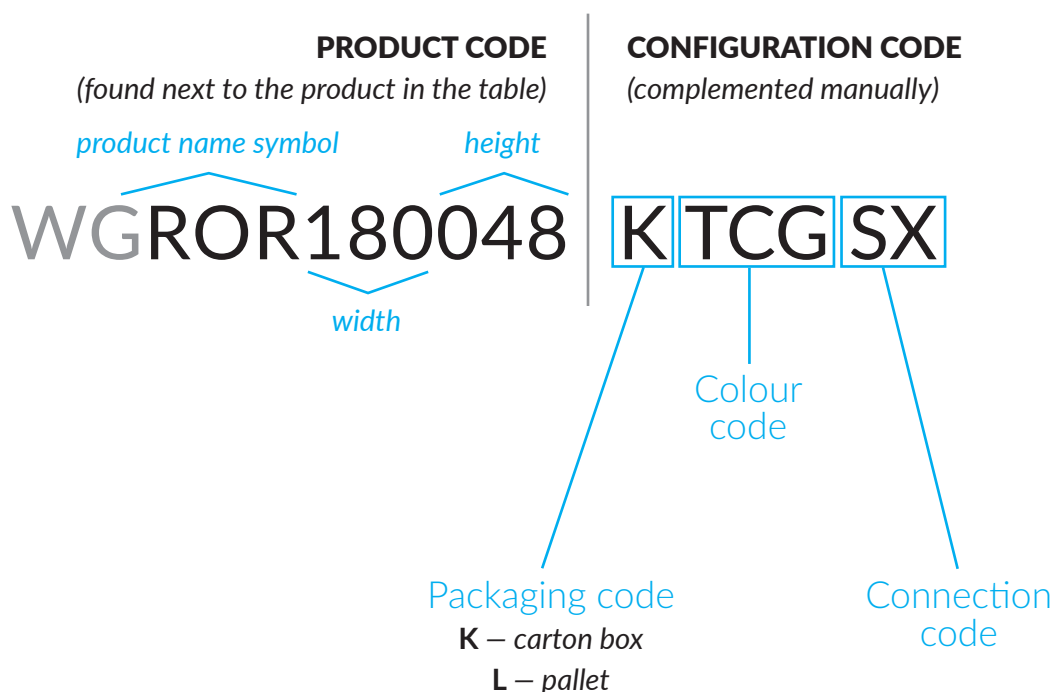

**WG** – water or dual fuel, central heating towel rail or radiator